



# NOTIFIER Black Book

NOTIFIER Black Book of Fire Detection and Alarm Systems

## of Fire Detection and Alarm Systems

- System Design
- Point Detection
- NOTIFIER INSPIRE™ Fire Alarm Control Panels
- Connected Life Safety Services (CLSS)
- High Sensitivity Point Detection
- Beam Detection
- Detection Technologies - Point Detection to Air Sampling
- Flame Detection
- Wireless Fire Detection
- Audible and Visual Alarms
- Li-ion Tamer Rack Monitor
- Emergency Voice Communication
- Paging Systems
- Central Battery Systems and Emergency Lighting
- Advanced Alarm Management

### NOTIFIER by Honeywell

Building 5, Carlton Park, Narborough,  
Leicester, LE19 0LF  
United Kingdom  
Tel: +44 (0) 203 409 1779  
[www.notifierfiresystems.co.uk](http://www.notifierfiresystems.co.uk)

All specifications are subject to change without notice.  
NOTIFIER® is a registered trademark of Honeywell International Inc.  
©2024 by Honeywell International Inc. All rights reserved.  
Unauthorized use of this document is strictly prohibited.



# Contents

---

<b>1. Fire system design</b>	6
<b>2. Fire system categories</b>	10
<b>3. Detection and alarm zones</b>	16
<b>4. Detecting fire – overview</b>	20
<b>5. Point Detection</b>	28
<b>6. NOTIFIER INSPIRE™ Fire Alarm Control Panels</b>	40
<b>7. Connected Life Safety Services (CLSS)</b>	48
<b>8. High Sensitivity Point Detection</b>	54
<b>9. Beam Detection</b>	62
<b>10. Detection Technologies - Point Detection to Air Sampling</b>	76
<b>11. Flame Detection</b>	96
<b>12. Wireless Fire Detection</b>	100
<b>13. Audible and Visual Alarm Devices</b>	110
<b>14. VA/PA Voice Alarm and Public Address Systems</b>	120
<b>15. Lithium-Ion Battery Off-Gas Detection</b>	142
<b>16. EVCS – Emergency Voice Communication Systems</b>	146
<b>17. Paging Systems</b>	156
<b>18. Central Battery Systems and Emergency Lighting</b>	164
<b>19. Eliminating Nuisance Alarms</b>	172
<b>20. Advanced Alarm Management</b>	178
<b>21. Continuing Professional Development (CPD) Programme</b>	192
<b>22. Detector Selection Quick Guide</b>	196

## **Introduction**

---

This guide provides a basic overview to anyone involved in the design or action of a fire detection system. It will identify the current legislative requirements as well as clarify the responsibilities placed on the three key roles involved with the provision of a new system, namely the Designer, Installer and Commissioning Engineer, as well as reminding the End User or Owner/Occupier what part they play in ensuring that the best possible system is supplied to protect life and property from fire.

It is important that everyone involved is conversant with the current British Standard Codes of Practice BS 5839-1:2017 for general buildings and BS 5839-6:2019 for dwellings, including those of multiple occupancy. The Installer should also be conversant with the British Standard relating to general wiring BS 7671.

The 'Notifier Black Book' is intended to offer practical advice and is not a substitute for any of the Standards or legislation referred to including:

### **Regulatory Reform Fire Safety Order 2005**

### **The Equality Act 2010 (formerly the Disability Discrimination Act 1995)**

### **Building Regulation Approved Document Part B**

### **Building Regulation Approved Document Part M**

### **Technical Booklet R under the Building Regulations (Northern Ireland) 2000**

### **Section 4 of Non-Domestic Technical Handbook (Scotland)**

All these documents in some way affect what is included in the system. However the Owner/ Occupier is ultimately responsible for the level of protection provided.

It is recommended that the Owner/Occupier carries out a Fire Risk Assessment to identify

the level of protection required i.e. one of the categories detailed within BS 5839-1:2017 (L1,L2,L3,L4,L5,M,P1 or P2).

The full responsibilities of the Owner/Occupier are detailed within the Regulatory Reform Fire Safety Order (RRO) that replaced the majority of existing laws within the UK from Oct 2006.

## **In this edition**

---

### **Changes to BS 5839-1:2017**

The principal changes introduced by this new edition have been summarised in the 'Fire System Design' chapter (pages 8 and 9).

### **Changes to BS 5839-8:2023**

'PA/VA Public Address and Voice Alarm' chapter has been updated in line with changes introduced by BS 5839-8:2023.

### **The use of Visual Alarm Devices (VADs)**

The 'Audible and Visual Alarms' chapter has been updated to include more detailed information on the use of Visual Alarm devices in line with EN 54-23 and the recent changes to BS 5839-1:2017.

### **Fire system remote connectivity**

Information has been included on the use of Graphical User Interfaces (GUI) and remote monitoring of fire detection and alarm systems.

### **Advanced alarm management**

Information has been included on EN54 Part 2 Type B Dependency approved systems providing an advanced alarm management system for sleeping risks and HOMO with the functionality of 'Testing and Silencing' those Alarms locally via a Local Silence button.

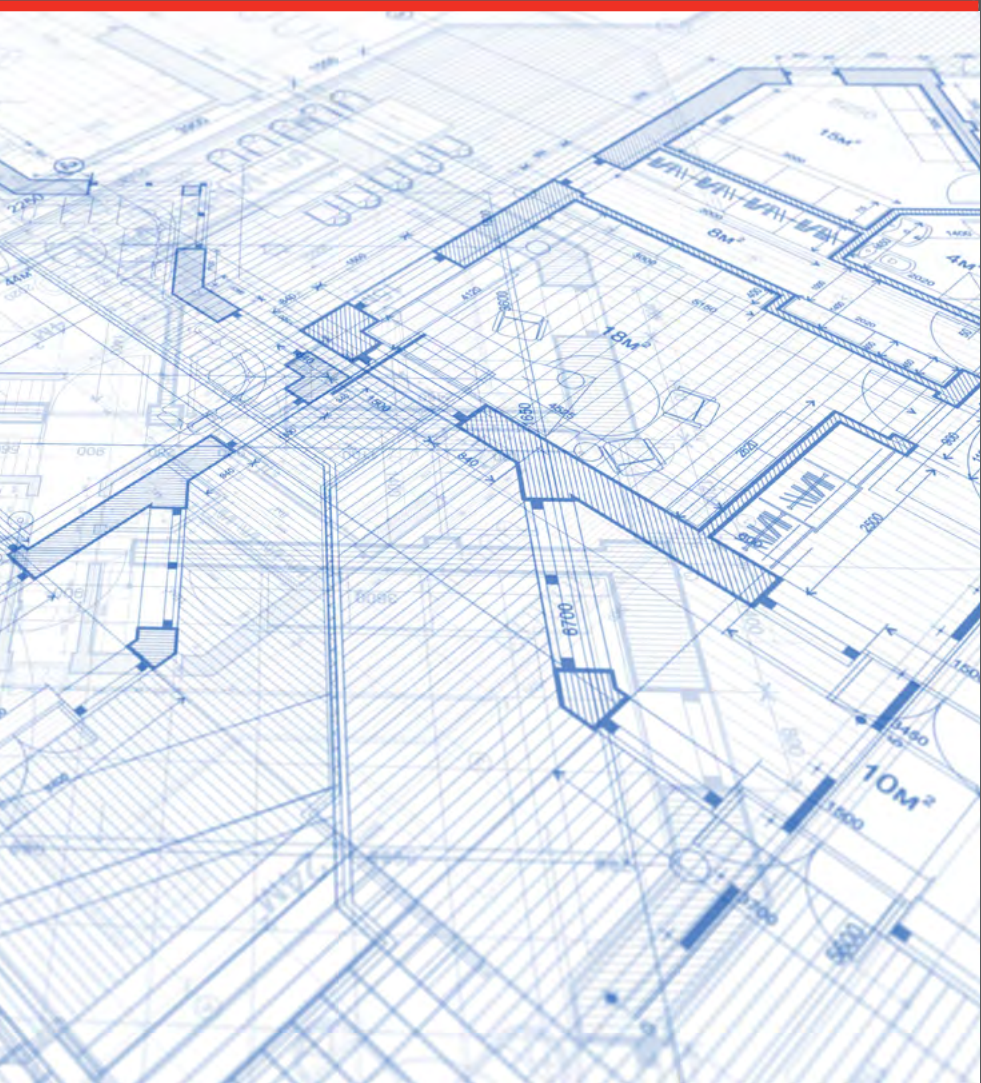

# Fire System Design

Any design should be prepared by a competent individual/organisation, who has consulted all interested parties and created a set of drawings, a specification, a Cause & Effect or fire plan, a list of Variations and completed a G1 Design certificate, detailed within BS 5839-1:2017.

If designs are undertaken without this research being carried out, the fire detection system is unlikely to comply with the legal requirements. This could result in prosecution of the parties involved, particularly those within the supply chain as well as the Owner/Occupier.

**WARNING:** Anyone who takes on the responsibility for design will do so at their own risk and design liability insurance is advisable.

# Fire System Design

## The designer's responsibilities

## BS 5839-1:2017

- › Agree the level of protection or category with Owner/Occupier
- › Justify any Variations and document reasons
- › Detail the detection and alarm zones
- › Prepare specification and drawings including;
  - › Siting of Manual Call Points
  - › Siting of point type heat and smoke detectors
  - › Siting of beam detectors
  - › Siting of any other forms of detection
  - › Specify type of cable for each circuit
  - › Specify type of system and equipment
- › Take into account the risk of false alarms use the 'pull out' application guide at the back of this booklet
- › Allow for correct level of Sounders and Visual Alarms
- › Prepare a fire plan or Cause & Effect chart
- › Sign a G1 design certificate

Note that BS 5839-1:2017 recommends that a fire detection system is designed by a competent person, who takes responsibility for completing the design and signing off of the 'Design certificate' (G1). This should not be confused with other certificates relating to Installation (G2) and Commissioning (G3), that are completed by the parties responsible for those parts.

Also, if the contract allows, it is suggested that the Designer witness tests the completed system to ensure the original design is still appropriate – the Design certificate can then be completed after any amendments are included.

The principle changes introduced by this new edition are as follows:

- a. In Clause 2:
  - › BS 8591, Remote centres receiving signals from alarm systems – Code of Practice replaces the reference to BS 5979, which has been withdrawn; and
  - › References have been added to:
    - › BS EN 54-21, Fire detection and fire alarm systems – Part 21: Alarm transmission and fault warning routing equipment;
    - › BS EN 54-29, Fire detection and fire alarm systems – Multi-sensor fire detectors – Point detectors using a combination of smoke and heat sensors;
    - › BS EN 54-30, Fire detection and fire alarm systems – Multi-sensor fire detectors – Point detectors using a combination of carbon monoxide and heat sensors; and
    - › BS EN 54-31, Fire detection and fire alarm system – Part 31: Multi-sensor fire detectors – Point detectors using a combination of smoke, carbon monoxide and optionally heat sensors.
- b. In Clause 3, the definition of "critical signal path" has been expanded to include transmission equipment for the routing signals to alarm receiving centres and the definition of "false alarm" has been changed to refer to "environmental false alarms".
- c. In Section 3 a new definition of "unwanted fire signal (UwFS)" has been added, taking into account the effect on the fire and rescue service.

- d. In 8.2 the multi-sensor detectors are now considered as one of the detection options for Category L3 and L4 systems and in escape routes for Category L1 systems. An informative note explains the process of designing Category L2 systems.
- e. In 11.2 and 20.2b, it is recommended that a protective cover is fitted to a Type A Manual Call Point to help prevent false alarms.
- f. 11.2 now recommends that alarm transmission and fault warning routing equipment should conform to the requirements specified in BS EN 54-21.
- g. 15.2 recommends that alarm receiving centres to which fire alarm signals are relayed should conform to BS 8591 and have in place an agreement with the appropriate fire and rescue service to pass on fire signals from fire alarm systems at the monitored property.
- h. 15.2 also includes a recommendation that, where fire alarm signals are routed via the routing equipment of an intruder alarm system, the standby power supplies for the routing equipment should conform to 25.4.
- i. In 19.2.2, it is acknowledged that, in premises, other than residential care homes, that generate a high number of unwanted fire alarm signals, automatic transmission of a signal to an alarm receiving centre may be delayed pending investigation of alarm signals from these devices.
- j. Subclause, 21.1.7 has been introduced specifically addressing video fire detectors, re-grouping text which was in different subclauses in the 2013 edition of the code.
- k. The text in 21.1.8 commentary explains detection principle choices involving single sensor detectors and multi-sensor detectors.
- l. Attention is drawn in Clause 22 to the need to consider field testing of hard-to-access detectors when designing the system.
- m. In 22.9 and Table 3, it is recommended that the limits specified for ceiling heights should only be used as guidance for vertical or flue-like structures, such as lift shafts and stairwells.
- n. In 25.2, the recommendation to provide double pole isolation has been replaced with a recommendation to provide local safe isolation. An informative note explains what is meant by "special tool".
- o. In 26.2, the recommendations for cables, wiring and other interconnections have been updated to reflect the currently available standards: BS EN 60702-1, BS EN 60702-2, BS 7629-1 and BS 7846. In addition, the duration of survival of cables has been referred to the tests in BS EN 50200 and BS 8434-2.
- p. The heading of Clause 29, "Electrical safety", has been replaced by the new heading "Electrical Earthing".
- q. Section 3 introduces the concept of "unwanted fire alarm signals". To minimise the risk of false alarms and unwanted fire alarm signals, it recommends that Manual Call Points should be fitted with protective covers and that systems that incorporate connection to an alarm receiving centre should have this connection disabled during the soak period.
- r. Annex E (informative), gives advice regarding selection and application of fire detectors.
- s. Annex F in the 2013 edition, which gave guidance on Visual Alarm Device illumination characteristics, has been removed as it duplicated the information in the referenced code: LPS CoP 0001 [1].

# Fire System Categories

Before a fire protection system can be designed, it is necessary to define the main objectives of the system.

This is normally determined by a fire risk assessment, and should be provided as part of the fire system specification. BS 5839-1:2017 defines three basic categories of fire detection system.



# Fire System Categories

## Category M systems

Category M systems rely on human intervention, and use only manually operated fire detection such as break glass Call Points. A Category M System should only be employed if no one will be sleeping in the building, and if a fire is likely to be detected by people before any escape routes are affected.

Any alarm signals given in a Category M system must be sufficient to ensure that every person within the alarm area is warned of a fire condition.

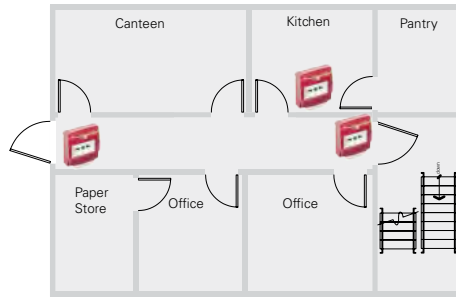

## Category L systems

Category L systems are automatic fire detection systems intended to protect life. The category is further sub-divided as follows:

**Category L5:** In a Category L5 system certain areas within a building, defined by the fire system specification, are protected by automatic fire detection in order to reduce the risk to life. This category of system may also include manual fire protection.

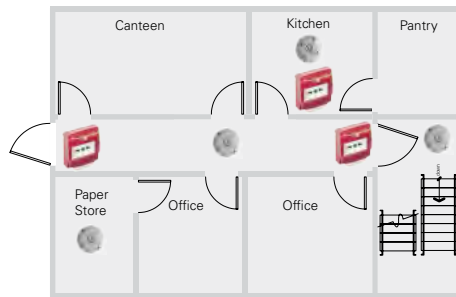

**Category L4:** Designed to offer protection to the escape routes from a building. The system should comprise Category M, plus smoke detectors in corridors and stairways.

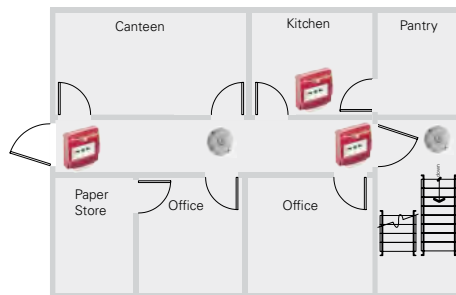

**Category L3:** Intended to offer early enough notification of a fire to allow evacuation before escape routes become smoke logged. Protection should be as for Category L4 with the addition of smoke or heat detectors in rooms opening onto escape routes.

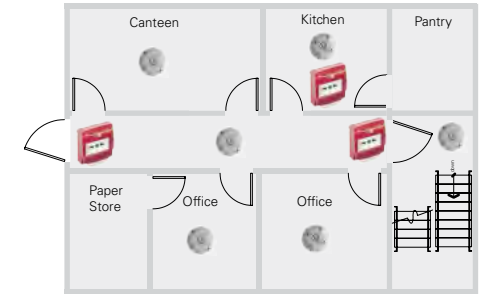

**Category L2:** Objectives are similar to Category L3, however additional protection is provided for rooms at higher risk. Protection should be as for Category L3, plus smoke detectors in specified rooms at high risk and documented within specification.

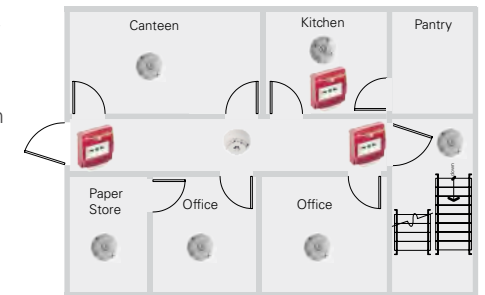

**Category L1:** The highest category for the protection of life. Intended to give the earliest possible notification of a fire in order to allow maximum time for evacuation. Automatic and manual fire detection installed throughout all areas of the building. Smoke detectors should be employed wherever possible to protect rooms in which people can be expected to be present.

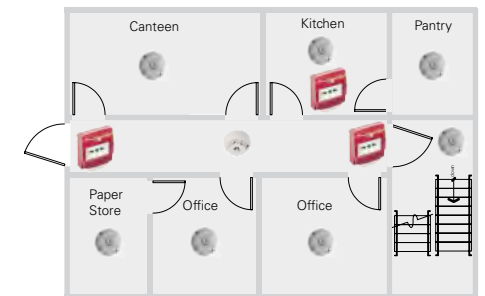

Similarly to Category M systems, all alarm signals given in a Category L system must be sufficient to warn all those people for whom the alarm is intended to allow for a timely evacuation.

Protection of voids should be considered in line with the protection category and fire risk assessment.

# Fire System Categories

## Category P systems

Category P systems are automatic fire detection systems whose primary objective is to protect property.

The category is sub-divided as follows:

**Category P2:** Intended to provide early warning of fire in areas of high hazard, or to protect high-risk property. Automatic fire detection should be installed in defined areas of a building.

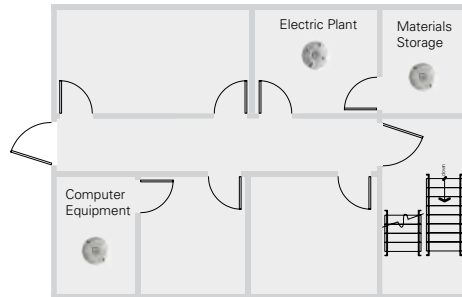

**Category P1:** The objective of a Category P1 system is to reduce to a minimum, the time from the ignition of a fire to the arrival of the Fire Brigade. In a Category P1 system, fire detectors should be installed throughout a building. In a Category P system, unless combined with Category M, it may be adequate for alarm signals simply to allow fire fighting action to be taken, for example, a signal to alert a responsible person to call the Fire Brigade.

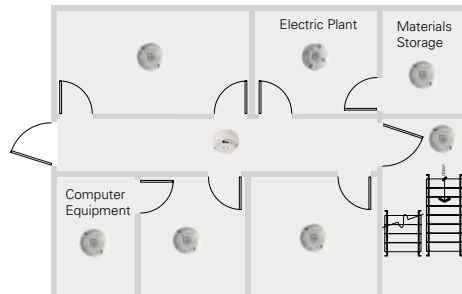

## Manual Call Points

People can often still detect a fire long before automatic fire detectors; hence Manual Call Points are important components of fire detection systems in occupied buildings to ensure timely evacuation in the case of fire. All call points should be approved to EN54-11, and should be of type A, that is once the frangible element is broken or displaced the alarm condition is automatic.

All call points should be fitted with a protective cover which is moved to gain access to the frangible element.

Manual Call Points should be mounted on all escape routes, and at all exit points from the floors of a building and to clear air. It should not be possible to leave the floor of a building without passing a Manual Call Points, nor should it be necessary to deviate from any escape route in order to operate a Manual Call Point. Call points mounted at the exits from a floor may be mounted within the accommodation or on the stairwell. A Manual Call Point within a staircase should be connected to the zone associated with that floor and ideally be mounted on the accommodation side of the corridor exit. In multiple storey buildings where phased evacuation is to be used, call points should be

mounted within the accommodation to avoid activation of call points on lower levels by people leaving the building.

In order to provide easy access, call points should be mounted 1.4m from the floor (a lower mounting height is acceptable in circumstances where there is a high likelihood that the first person to raise an alarm of fire will be a wheelchair user) and should be clearly visible and identifiable. The maximum distance anyone should have to travel in order to activate a Manual Call Point is 45m, unless the building is occupied by people having limited mobility, or a rapid fire development is likely, in which case the maximum travel distance should be reduced to 25m. Call points should also be sited in close proximity to specific hazards, for example kitchens or paint spray booths.

Note: In order to comply with the requirements of Building Regulations Approved Document Part M, which requires electrical switches including Manual Call Points (MCPs) to be mounted no higher than 1.2m from the floor so that they are accessible for disabled people, a minor difference (e.g. less than 300 mm) in mounting height need not be regarded as significant, nor need it be recorded as a variation.

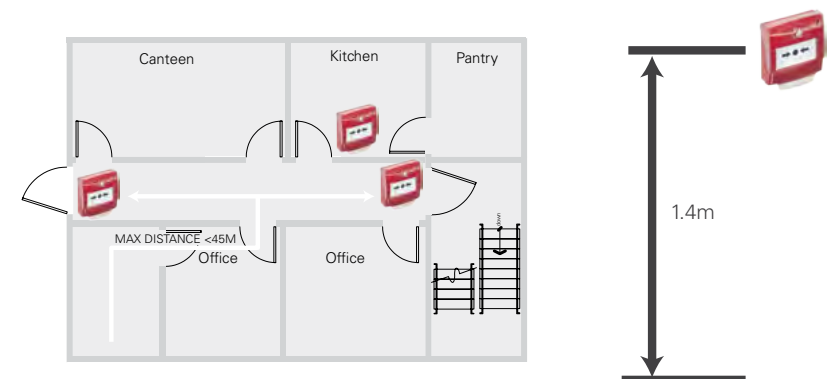



# Detection and Alarm Zones

Generally a building is broken down into smaller compartments to enable the Firefighters to locate the fire as quickly as possible.

Even if the system is addressable it is still considered beneficial to have a separate 'at a glance' indication of the location of the fire. These compartments of a building are called detection zones, which need to comply with the following criteria.

# Detection and Alarm Zones

## Detection zones

A detection zone should cover no more than one storey, unless the total floor area is less than 300m<sup>2</sup>. Voids in the same fire compartment should be included in the same floor zone. The maximum floor area of a zone should not be greater than 2,000m<sup>2</sup>, except for some large open plan areas that incorporate Manual Call Points only, which can be extended to 10,000m<sup>2</sup>.

The maximum search distance for the Firefighters to see the seat of the fire within a zone should not exceed 60m, assuming the route taken is the worst possible option. Vertical structures like stairwells, liftwells etc. should be considered as separate zones.

A Manual Call Point within a staircase should be connected to the zone associated with that floor and ideally be mounted on the accommodation side of the corridor exit. Automatic sensors on the stairwell remain as part of the stairwell detection zone.

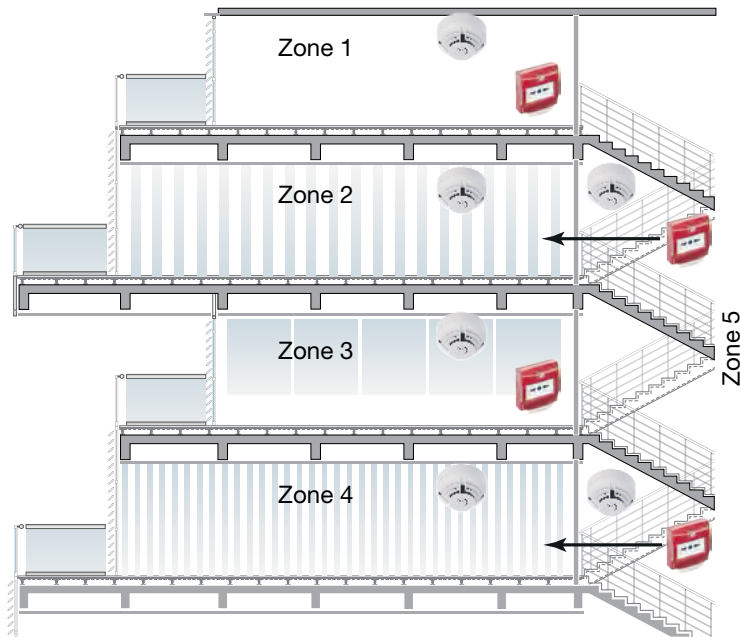

## Alarm zones

An alarm zone is clearly defined within the Standard but generally is an area of the building coinciding with the fire compartment boundaries. There must be a clear break between these alarm zones to ensure alert and evacuation messages are not overheard from adjacent areas.

The only other criteria is that an alarm zone may consist of a number of detection zones but not vice versa.

Alarm zones are only required when phased or staged evacuation is required. It is therefore important that care should be taken to ensure only one message is heard at any one time particularly where two alarm zones are attached.

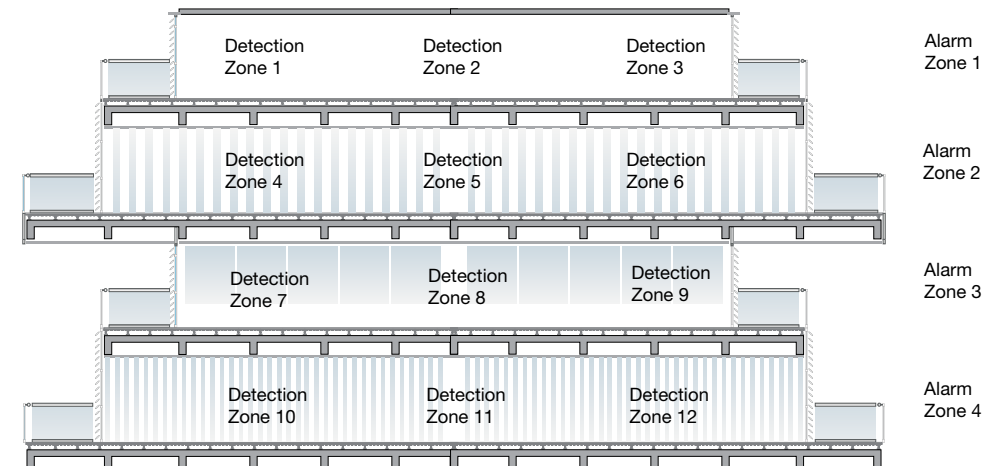



# Detecting Fire – Overview

This section will outline the various types of detection and aid in the selection of the most appropriate detection type for a specific location. This is a key part of fire system design, which is essential to enable a system to be designed to meet the needs of a project and provide best value for money - whilst providing the earliest warning of fire without the risk of a false alarm.

Every potential location for a detector is different, just as every building manager has different priorities. It is therefore worth trying to visualise the type of fire that is likely to occur in a particular room or area and also to familiarise oneself with the application and the risks that could give rise to a false alarm.

At the end of this booklet, a pull-out section is attached, showing a full application guide for all detectors including the latest Notifier multi-sensor SMART range with settings for every application and risk. By combining the right detectors and controls, you can provide a tailored solution to fit any project.

# Detecting Fire – Overview

The key to a reliable, robust fire system is having the right detector in the right place. If the system is too sensitive it will generate unwanted alarms and won't be regarded as giving accurate information. Not sensitive enough, and it won't protect what it needs to.

## Heat detectors

Heat detectors are normally used in environments where a smoke detector might generate false alarms, for example, kitchens or near shower rooms (unless environmentally sealed for direct installation in shower rooms where heat probes may be considered).

Rate of Rise heat detectors will alarm if the temperature rises very quickly, or if the temperature reaches a set threshold. This type of detector would be the first choice in an environment where a smoke detector could not be used. In some environments, such as unvented boiler rooms, fast rates of rise of temperature can be expected normally, meaning that there would be a risk of false alarms when using a Rate of Rise device. As their name implies, fixed temperature detectors give an alarm once the temperature has reached a preset threshold, most commonly 58°C or 78°C for EN 54-5 Class AS or BS respectively.

## Optical detectors

The default choice for most locations is an optical smoke detector. These detectors are tested across the complete range of EN 54 fires, however they are most sensitive to smoke containing large particles from around 0.4 to 10 microns, such as that given off by smouldering fires. Ionisation used to be common but is now seen as not environmentally friendly because of the radioactive element.

Optical detectors may signal an alarm condition because dust is present rather than smoke, so we need a way to de-sensitise the system without failing to react to real smoke. The simplest strategies allow the sensitivity to be reduced but because of the need to retain the ability to detect a real fire there is a limitation on how much the detector can be de-sensitised. A simple confirmation delay may also be added, in which case the need to limit delays applied to ensure appropriate detection of a real fire remains. Since these simple measures cannot, in themselves provide the right compromise, the logical thing to do is to look at something other than the visible smoke signal to confirm the alarm.

## Multi-sensor fire detectors

Adding a thermal (temperature triggered) element so that the sensitivity can be adjusted if there is a temperature rise as well as optically detected smoke.

This is the simplest form of multi-criteria detection and illustrates why it's important for the detector to use all of the available criteria to make the alarm decision. Some systems just put a smoke detector and a heat detector in the same housing and operate them as a two-stage 'coincidence' system. This means that the system will be protected against unwanted alarm but will not detect a real fire until significant heat is developed – by which time the fire will have taken hold. This system would also require the detector spacing to be used for heat detectors rather than smoke detectors, resulting in the use of up to twice as many detectors in a large area and not complying with the recommendations of BS 5839 Part 1 2017 in escape routes.

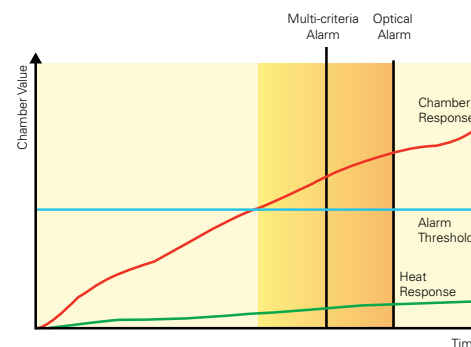

## Application guidelines for multi-sensor fire detectors

A multi-sensor fire detector is one that incorporates – in a single mechanical enclosure – sensors which detect more than one physical or chemical phenomenon of a real fire. The overall fire performance is determined utilising a combination of the detected phenomena. Sensors included in currently available multi-sensor fire detectors are shown in the detection overview.

Single-sensor fire detectors are perfectly suitable in most instances. However multi-sensors can provide advantages in certain applications, for example:

- › When the expected fire is of a specific type (see quick detection selector guide at the back of this book).
- › When there is a specific threat from false alarm.
- › When the risk varies at different times of day.
- › When it is deemed advantageous to standardise on one type of detector for all areas of the building.

Some multi-sensor fire detectors may be configured to respond differently for specific applications. This may be achieved, for example, by adjusting the contribution from each individual sensor to the overall fire decision. It should be noted that even on approved detectors, some configurations may not comply with standards.

# Detecting Fire – Overview

## Notifier SMART multi-criteria detection

All Notifier SMART detectors are enhanced optical smoke detectors. This means that they can be used in escape routes and should be spaced as smoke detectors unless full coverage is required while the smoke detection elements are completely disabled. The smoke detection can be disabled manually until re-enabled, or automatically, according to the time of day.

The SMART detectors are more than just multi-criteria detectors though; they also have a self-optimising sensitivity adjustment. Many systems have a drift compensation facility so that as detectors accumulate contamination between cleaning intervals, the sensitivity is not increased by this contamination but the SMART detectors can also make themselves more sensitive again if the level of contamination decreases.

An example of this might be an office in which carpet vacuuming or just daily traffic disturbs dust that can be 'seen' by the detector. The SMART algorithm in the detector will adjust the sensitivity to compensate – which means that a real alarm will still be detected fast but dust will not trigger an unwanted alarm. Once the area is empty and the dust has settled the detector will 'see' the clean air and return to a higher sensitivity level – thus the detection of alarm when the area is empty is as fast as it can be, this allows maximum time for investigation and fighting a small, incipient fire while it is safe to do so.

True multi-criteria detectors also incorporate more, different detection elements to make a more informed decision about fire. The SMART<sup>3</sup> adds an infrared element to the optical-thermal

detector. This is used with the micro-processor to detect the characteristic flicker of flame, thus overcoming the optical element's inherent lack of sensitivity to fast-flaming fires, which do not generate much visible smoke. The speed of this detection method (which literally works at the speed of light) allows the a very fast response to the a very broad range of fires while allowing the optical element to be further de-sensitised for resistance to unwanted alarm.

The SMART<sup>4</sup> detector is the ultimate multi-criteria smoke detector. It adds the detection of carbon monoxide (CO) to the fire decision. Unlike fast-flaming fires, slow fires beginning to develop but have yet to ignite (this is called pyrolysis) produce significant quantities of CO. A CO detector can detect fires almost before they start. CO is also produced by almost all fires so it is an excellent complement to the optical element to confirm that it is smoke and not dust that has been detected.

All of the above enhancements to detection can be applied without the need for user intervention. They are independent of the application of coincidence and time-based systems that limit the signalling of alarm while an investigation by staff occurs. (This is a different approach and is discussed in the 'Advanced System Configuration and Connectivity' chapter later in this guide).

The tables on the following pages assist in determining which detector is most suitable for most locations, both to minimise false alarm risk and to maximise the protection offered by the detection system.

## Aspirating Smoke Detection

ASD systems draw air samples continuously from the monitored area through a pipe system fitted with sampling holes at regular intervals. The sampled air is then analysed for smoke particles and an alarm is raised if smoke is present. The system is active, continually drawing air samples from the risk. Details on the application of ASD systems are provided later in this guide.

## Duct Smoke Detectors

Should a fire occur, air duct systems have the capability to transfer smoke, toxic gases, and flame from area-to-area. Sometimes smoke can be of such quantity as to be a serious hazard to life safety unless blowers are shut down and dampers are actuated.

The primary purpose of duct smoke detection is to prevent injury, panic, and property damage by reducing the spread (re-circulation) of smoke. Duct smoke detection can also serve to protect the air conditioning system itself from fire and smoke damage, and can be used to assist in equipment protection applications, for example, in the ventilation/ exhaust duct work of IT server rooms.

In order to reliably detect smoke within a duct system, detectors specifically designed for this application should be used. Duct detectors should not be used as a substitute for a building's regular fire detection system.

## Optical Beam Detectors

Optical beam detectors work on the principle of projecting a beam of light across a room, which is attenuated when smoke is present thus allowing an alarm to be given.

There are two forms of beam detector: emitter and receiver separate (single path), requiring separate wiring both to the emitter and receiver, and reflective in which the emitter and receiver are mounted in the same box, and the beam is shone onto a reflective material at the far side of the room (dual path). Since an optical beam detector senses smoke across the entire smoke plume, it tends to be less affected by smoke dilution as the ceiling height increases than point type smoke detectors. In addition, a single beam detector can protect a large area - hence they are particularly suitable for protecting large high-ceilinged rooms such as sports arenas, warehouses and shopping malls.

Beam detectors are more complex to install than ordinary point smoke detectors. Details on the application of beam detectors are provided later in this guide.

# Detecting Fire – Overview

Detector type	Advantages	Disadvantages	Application examples	When to consider in place of optical
<b>Optical</b>	Sensitive to dense smoke Sensitive to slow-smouldering fires	Less sensitive to clean-burning fires that produce little smoke Can be affected by white dust, fumes or steam	Spaces with minimal risk On escape routes where smoke could obscure visibility of the route and exit signs	
<b>Thermal</b>	Good at detecting very clean burning fires e.g flammable liquids Less sensitive to most fires than other detectors – therefore greater immunity to false alarms Only minimum attention required during routine maintenance visits Range includes fixed 58°C, fixed 78°C and RoR with fixed temp 58°C	Less sensitive to most fires than other detectors Unlikely to respond to smouldering fires More heat detectors needed to cover an area than optical	Boiler rooms burning coal or coke, cold rooms, enclosed car parking areas Adjacent to cooking areas	A greater resistance to airborne particles and higher immunity to false alarms Not suitable where a warning of the presence of smoke is required e.g. sleeping accommodation Not suitable where a small fire would cause unacceptable damage
<b>SMART<sup>2</sup></b> Optical and thermal	Optical Heat detectors are able to combine the benefits of the two detectors Multi-sensor technology can enhance detection performance and resistance to false alarms Potential to disable optical element on a time related system	Optical element alone may suffer from false alarms from dust, steam etc.	Smouldering, smoky fires such as wood or cotton burning High energy fires caused by flammable liquids	Higher immunity to false alarms Addition of flammable liquid fire detection Ability to set elements on day/night mode Resistance to transient airborne particulates
<b>SMART<sup>3</sup></b> Optical smoke, thermal and infrared flame	IR element is sensitive to flame – looks into the room The combination gives better sensitivity to both smouldering and flaming fires Environmentally friendly replacement for ION detectors	May still generate alarm from prolonged exposure to dust	Reduces risk of false alarms in bedrooms with en-suite shower rooms e.g. hotels, student accommodation etc. Will detect a broad range of fires	Enhanced response times Greater flexibility (adjustable verification time) Higher false alarm rejection
<b>SMART<sup>4</sup></b> Optical smoke and thermal and infrared flame and carbon monoxide detection	The combination means fast response time to detect all types of fires Ultra-immune to non-fires, yet very sensitive to real fires Approved selectable scenarios for different applications e.g disco with synthetic smoke Combination of sensors = Combination of strengths	Premium price CO chamber has 6 year life	All applications where the cost of business interruption will be high e.g. airports, banking, manufacturing Locations where people are sleeping e.g. hotels, care homes, student accommodation Used where there is a high risk of nuisance alarms such as cooking fumes, steam, synthetic smoke	Faster detection of all fire types Excellent false alarm immunity
<b>Beam Detection</b>	Ideally suited to high ceiling applications Provides a cost effective solution for large open areas	Risk of false alarm if beam is broken or subjected to building movements	Spaces with high ceilings and large open areas such as factories warehouses and atriums	
<b>FAAST</b> Aspirating smoke detection (ASD)	High sensitivity Aspirating Smoke Detection (ASD) Can be a solution to access and environmental problems such as high bay warehousing, wash down areas, lift shafts Easier to maintain than a standard ceiling mounted optical detector Can be used with VIEW Detectors Advanced filtration systems enable use in dirty environments	Location of event only located by zone Filters require replacement periodically (depending on application)	Ideal for protecting spaces where even a small fire would be critical e.g. data centres, server rooms, electrical switch/distribution and process control Where aesthetics need to be preserved pipe-work can be hidden and sampling tubes can be discreet e.g. heritage sites Where vandalism is common e.g. detention centres, prisons Areas difficult to access to install or maintain, e.g. cable voids, lift-shafts, warehousing, cold stores, wash down and waste processing	Higher sensitivity to smoke than a standard smoke detector, therefore detecting fire long before smoke is visible When action is to be taken as soon as fire is perceived to be developing When protecting an area where access for maintenance is an issue
<b>VIEW™</b>	High sensitivity smoke detection Use in place of an aspirator – without moving parts, pipes, fans or dust filters Ability to pinpoint the location of a fire Costs less than Aspirating System (no pipework to install)		Ideal for protecting spaces where even a small fire would be critical e.g. data centres, server rooms – even within a single cabinet Locations where ‘priceless’ items are stored or displayed e.g. museums, heritage buildings	Detects smouldering fires before Optical Detectors When protecting valuable assets and earliest warning is essential



# Point Detection

The key to a reliable, robust fire system is having the right detector in the right place.

If the system is too sensitive it will generate unwanted alarms and won't be regarded as giving accurate information. Not sensitive enough, and it won't protect what it needs to.

# Point Detection

## Location and spacing of point fire detectors on flat ceilings

On a flat ceiling with no obstructions, the radius of protection of fire detectors is 7.5m for a smoke detector and 5.3m for a heat detector, and detectors should be mounted a minimum of 0.5m from a wall.

Some analogue multi-criteria detectors have a heat sensor only function, switched by the control panel, typically used to reduce the possibility of false alarms during the daytime when a building is occupied, reverting to multi-sensor operation at night time. If this type of operation is employed, the radius of protection for a heat sensor should be used.

This diagram gives a simple spacing plan based on these figures, however it should be noted that this might not be the most efficient layout for a given site; for example in larger areas, it is also possible to use a staggered layout, (see diagram on opposite page), which may reduce the number of detectors required. In practice, the layout of the room must be considered to obtain the most efficient detector layout.

When using a multi-sensor, consideration should be given to the configuration set up of the sensing element and the mounting height and spacing of each detector.

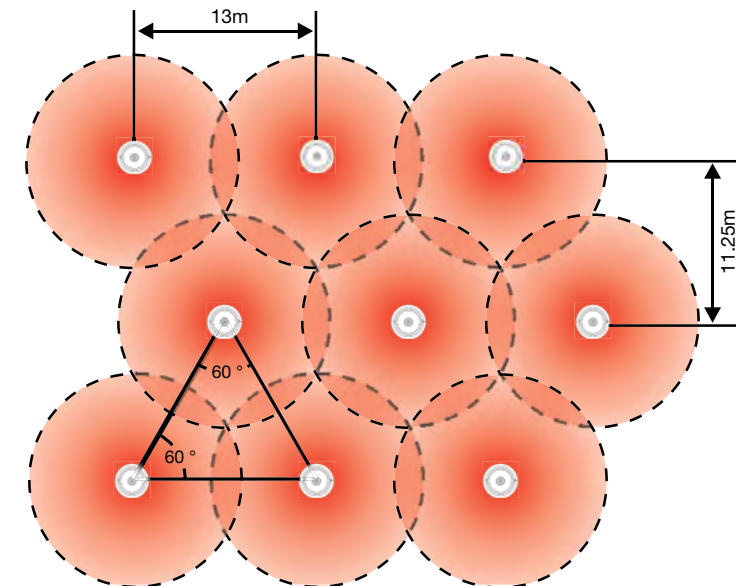
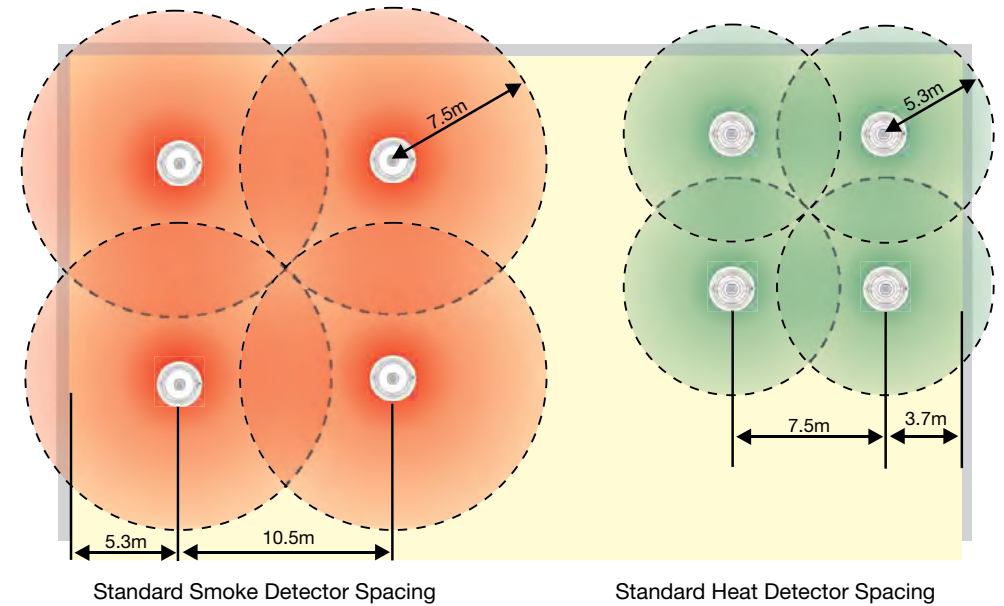

# Point Detection

## Ceiling height

Smoke or heat detectors can only detect fires once a certain amount of smoke or heat has reached the sensor. As the height of a ceiling increases, the time taken for smoke or heat to reach a sensor will increase, and it will become diluted with clean, cool air. As a result, maximum ceiling heights are limited as indicated in the table below.

Often, a boundary layer can form close to the ceiling, which is free of smoke and remains cool. To avoid this, and maximise the probability of detection, smoke detectors should normally be mounted with their smoke entry 25mm-600mm below the ceiling, and heat detectors should be mounted with their heat element 25mm-150mm

below the ceiling. Detector design normally ensures that the minimum requirement is met, but care needs to be taken if the detectors are to be stood away from the roof, for example mounting on an open lattice suspended ceiling.

Another problem that should be considered is the possibility of stratification of the air in a room into hot and cold layers, causing the smoke or heat to stop at the boundaries. This particularly affects high rooms or atriums, where beam detectors are often used. Stratification is very difficult to predict, and can vary, even within the same room as environmental conditions change.

Detector type		Max. ceiling height (m)
Heat detector conforming to EN 54-5 Class A1 (threshold 58°C)		9
High temperature heat detector conforming to EN 54-5 Class B (threshold 78°C)		7.5
Point smoke detector conforming to EN 54-7		10.5
Carbon monoxide detectors		10.5
Optical beam smoke detectors conforming to BS EN 54-12	Normal sensitivity	25
Optical beam detectors smoke detectors conforming to BS EN 54-12	Enhanced sensitivity (alarm at 35% attenuation or less)	40
Any ASD system approved to EN 54-20		10.5*
ASD system with: at least 5 Class C holes or at least 2 Class B holes		15*
ASD system with: at least 15 Class C holes or at least 5 Class B holes		25*
ASD system with: at least 15 Class B holes		40*

\* In some instances it may be satisfactory for systems to be installed at greater heights of up to 43m. In all situations where a variation exists, the risk should be assessed and performance tests should be considered to verify the system response. For further information, refer to the FIA Code of Practice: Design, Installation, Commissioning and Maintenance of Aspirating Smoke Detector (ASD) Systems. February 2012.

## Multi-criteria detection

When using a multi-criteria detector, consideration should be given to the configuration set up of the sensing element and the mounting height and spacing of each detector.

## Ceiling obstructions

Ceiling obstructions such as beams greater than 10% of the ceiling height should be treated as a wall, and will thus divide a room. Detectors should not be mounted within 500mm of such an obstruction.

If the depth of an obstruction such as a beam is less than 10% of the height of the ceiling, but greater than 250mm deep, then detectors should not be mounted any closer than 500mm

to the obstruction. Where an obstruction such as a beam or a light fitting is less than 250mm in depth, detectors should not be mounted any closer to the obstruction than twice its depth.

Where a ceiling comprises a series of small cells, for example, a honeycomb ceiling, or a series of closely spaced beams, for example, floor or ceiling joists, the recommended spacing and siting of detectors changes further, dependent on the ceiling height and the depth and spacing of the beams. Reference should be made to relevant standards for details (in the UK BS 5839-1:2017, 22.3.k Tables 1 and 2).

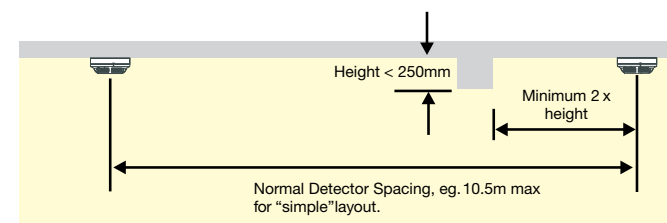
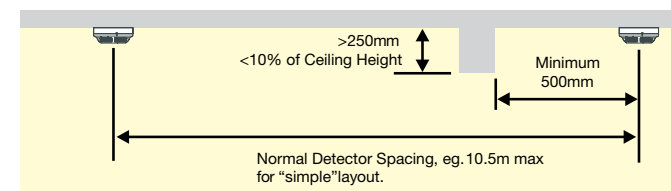
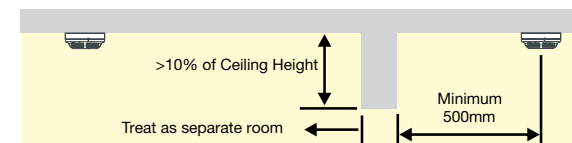

# Point Detection

## Sloping ceilings

Where the ceiling is pitched or sloping, the slope of the roof tends to speed the rise of smoke or heat to the apex, hence reducing the delay before the detectors are triggered.

For sloped roofs with a pitch height greater than 600mm for smoke detectors, or 150mm for heat detectors, a row of detectors should be placed within a maximum vertical distance of 600mm or 150mm for smoke or heat detectors respectively from the roof apex.

Sloped roofs rising less than 600mm for smoke detectors or 150mm for heat detectors may be treated as a flat ceiling.

Since the smoke or heat tends to rise faster up the slope, it is permissible to use a greater spacing for the row of detectors mounted in the apex of the roof: for each degree of slope of the roof, the spacing may be increased by 1% up to a maximum of 25%.

Where the roof slopes are unequal, the spacing down the slopes can be unequal, however, along the roof apex spacing the lesser of the two figures should be used, in this example 10.5m + 18%.

Where the slope finishes within the adjusted detection radius, the standard distance to the next row of detectors, 10.5m, should be used. Care must be taken when placing the next row that no gaps are left in detection coverage.

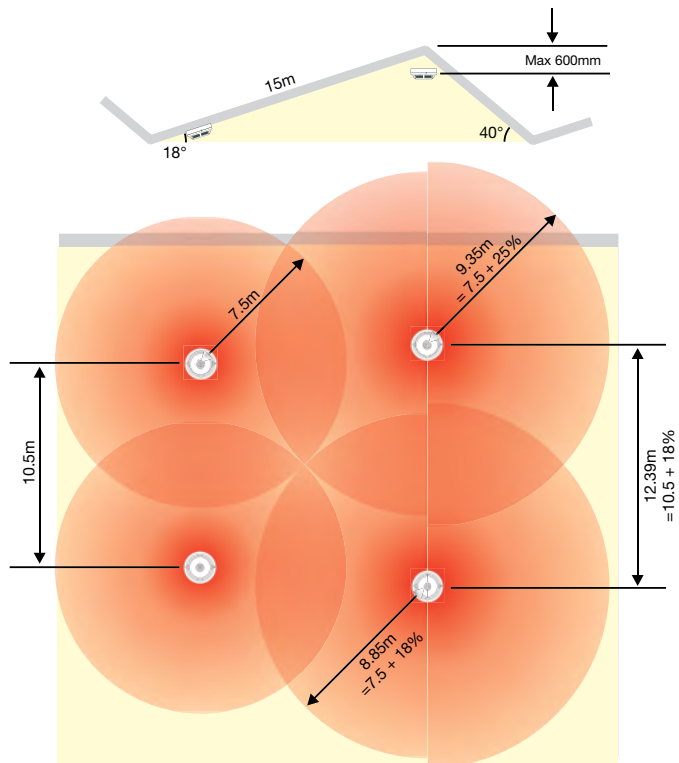

## Partitions and racking

Where the gap between the top of a partition or section of racking and the ceiling is greater than 300mm, it may be ignored. If the gap is less than 300mm it should be treated as a wall.

To maintain a free flow of smoke and heat to the detector, a clear space should be maintained for 500mm in all directions below the detector.

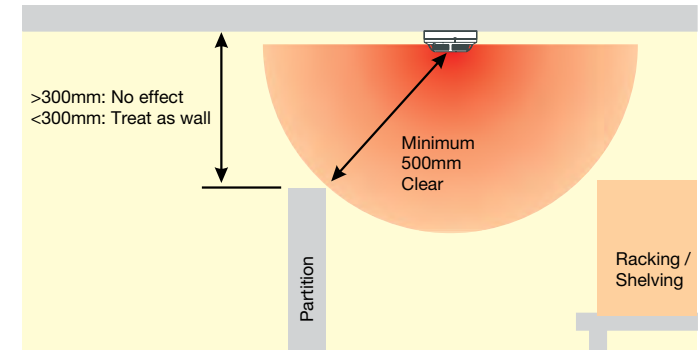

## Corridors

In corridors less than 2m wide, detectors should be spaced at a distance of 15m for smoke detectors and 10.6m for heat detectors, with the maximum dimension to a wall at the end of the corridor being 7.5m and 5.3m respectively.

In narrow rooms and corridors greater than 2m wide, due to the way that the coverage radii of detectors intersect with the walls of the corridor, the spacing between detectors will increase. The diagram below shows how, for a room 6m wide, the spacing for smoke detectors can be increased from the standard 10.5m.

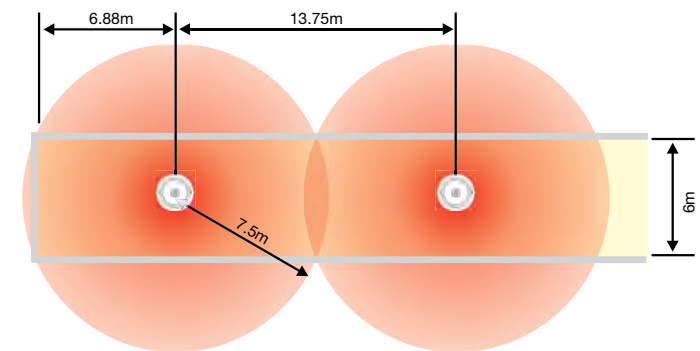

# Point Detection

## Short corridors and inner rooms

In Category L2/L3 systems, detection should be installed in all rooms that open onto the escape route, except that rooms opening onto corridors of less than 4 metres in length need not be protected, providing that fire resisting construction, including fire doors, separates these corridors from any other section of the escape route. See clause 8.2d.

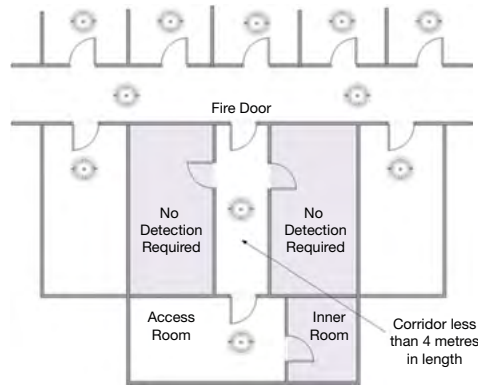

## BS7273-4 door release system

BS 7273 Part 4 2015 is the Code of Practice governing release mechanisms for doors. The door release system should be designed to ensure the fail safe actuation of release mechanisms in conjunction with the existing output module and wider fire system to meet the requirements of section 5 of BS 7273-4 Category A Installations.

Recommended application of BS 7273 Part 4 Category A. The Code of Practice includes tables of the types of installation where such a fail safe measure should be applied. The following are examples of where only Category A actuation is recommended and should be specified relating to the position of doors:

- › In a compartment wall separating buildings
- › Forming part of the enclosures of any stairway in a hotel, boarding house, hall of residence, house in multiple occupation (HMO), hostel, residential care premises, a building containing apartments, a place of public entertainment or similar premises to any of the above (excluding hospitals)
- › Forming part of the enclosures of a stairway that is the only stairway serving a building (or part of a building) which has more than one storey above or below the ground storey (other than in dwellings)
- › In premises occupied by, or open to, the public, including shops and shopping centres, hotels, boarding houses, public houses, cinemas, theatres, museums, galleries, leisure centres, transportation terminals and similar premises
- › In schools

## Stairwells and lift shafts

Internal stairwells and lift shafts and other vertical service ducts through a building provide a clear path for smoke to pass between floors of a building as if they were chimneys. It is therefore important to protect these, preferably using smoke detectors.

All vertical shafts through a building must be protected by a smoke or heat detector at the top of the shaft, and by a detector within 1.5m of each opening onto the shaft.

In internal stairways, a detector should be mounted on each main landing. In addition, if the detectors on the landings are separated by more than 10.5m, intermediate detectors should be mounted on the underside of the stairs.

Detectors should also be fitted into any room opening directly onto a stairway other than a toilet cubicle.

Clause 8.2f, recommends that for Categories L1 and P1, rooms such as toilets and bathrooms, lobbies and stairways, need not be protected if they are low fire risk. However, for Category L3, L2 and L1, rooms opening onto the escape routes should have protection.

Care should be taken when interpreting this section, as if the toilet area is considered high risk, then detection should be provided, but the lobby being low risk would not need protection. However, if the toilet is deemed low risk and no detection is provided, to comply with covering rooms leading onto an escape route, then the lobby would require protection.

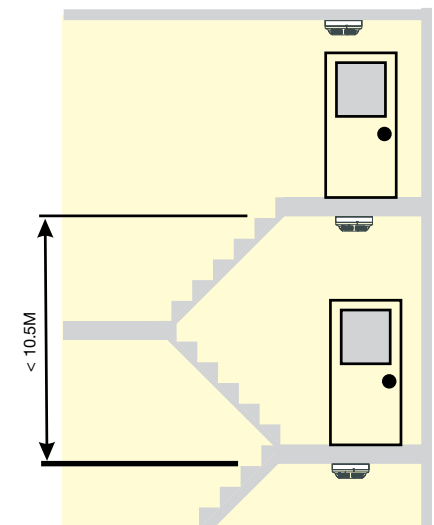
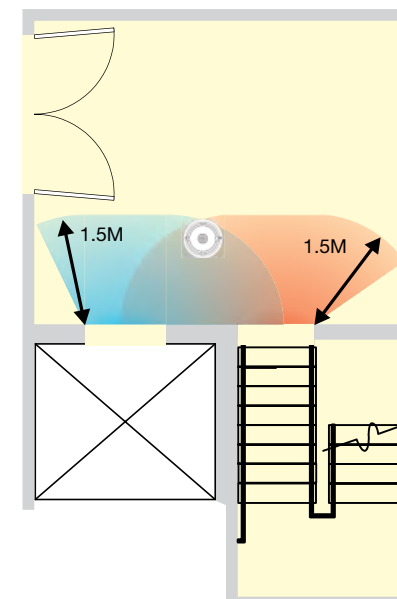

# Point Detection

## Voids and false ceilings

Detectors need not normally be installed in voids less than 800mm deep, unless on the basis of a fire risk assessment it is thought that fire or smoke could spread extensively through the voids before detection, or unless the fire risk in the void is such as to warrant protection. Use of heat and smoke detectors in voids greater than 800mm high is dependent on the protection category, and fire risk assessment.

Where they are installed into voids, a detector's sensing element should be mounted either in the top 10% or the top 125mm of the void space, whichever is greater. Although it can be difficult to install detectors the correct way up in void spaces, care should be taken as incorrect orientation of a detector can lead to increased ingress of dirt and dust, leading to reduced maintenance intervals, and possible nuisance alarms.

Detectors above a false ceiling may be used to protect the area below it, if the false ceiling is perforated uniformly across the complete area of the ceiling, with the holes making up over 40% of the ceiling surface area, having a minimum size of 10mm and the false ceiling having a thickness of less than three times the dimensions of the perforations.

In all other cases, the areas above and below a false ceiling should be treated as separate, and thus should be protected separately with detectors below the ceiling, and if necessary, in the void above the ceiling.

## Lantern lights

A detector should be mounted in any lantern light used for ventilation or having a height exceeding 800mm. The temperature in lantern lights can change rapidly owing to heating by sunlight, which means that rate-of-rise heat detectors should not be used and heat detectors should be protected from direct sunlight.

## Ceilings or air handling units

One of the most common mistakes is to mount a smoke sensor adjacent to the air conditioning intake or outlet grill. The minimum distance between the two should be at least 1 metre (and further, if possible).

This is due to the fact that smoke may have difficulty penetrating the sensor when the air conditioning is switched on. There is also a greater risk of the sensor becoming contaminated and giving rise to false alarms.



# NOTIFIER INSPIRE™ Fire Alarm Control Panels

The INSPIRE intelligent addressable Fire Alarm Control Panel lies at the core of a connected infrastructure which combines exceptional fire detection technology, cutting edge warning and evacuation devices and super-fast networking capability, all in one intuitive and easy to use system.

## Standards

- › Compliant to EN54-2:1997 + A1:2006, see option with requirements clauses
- › Compliant to EN54-4:1997 + A1:2002 and A2:2006

The INSPIRE series of Fire Alarm Control Panels from NOTIFIER by Honeywell are a modular, easy to use networkable systems available in 10U and 15U enclosures. It exploits NOTIFIER's Opal digital protocol to maximise the speed and efficiency of fire detection and alarm whilst supporting legacy CLIP protocol devices. The large 10" colour display with its intuitive interface touch screen operation and menu driven features, allows quick and easy operation of the system.

INSPIRE's powerful ID<sup>2</sup>net network with advanced networking capabilities is supported by a comprehensive connected tools suite which enables significant efficiencies on and off site with easier access, programming and maintenance of the system.

# Features and benefits

## Ease of use

- › The 10" display gives clear, user defined data on the status of the system to provide error free situation management
- › Graphical and text Cause & Effect programming tools support on and off site commissioning
- › The modular design allows the system to easily adapt and change as the building use and size changes
- › Comprehensive "Cause & Effect" programming capability
- › System extensions and adaptations can be made quickly without compromising fire cover and without extensive re-cabling
- › Cable entry through adjacent knock out blanks
- › Custom logo on quiescent screen

## Extended capacity

- › The INSPIRE panel supports up to 10 easily swappable modules in a 10 U enclosure and up to 14 in a 15U enclosure
- › The display guides users through all operations and data logs with context driven menus and icons
- › Highly resilient Opal Advanced Protocol system, able to pinpoint a loop fault whilst maintaining full system operation
- › Day/Night mode configurable for site specific requirements
- › Touch screen and 3 manual control buttons and on screen tips for user guidance

## Specifications:

- › 10" high-definition capacitive touchscreen
- › 6.7A power supply (240W PSU) with 4 NAC circuits
- › 2-8 loops capacity
- › 318 intelligent devices per loop
- › 750ma alarm load per loop
- › Indicator, action and mimic annunciator supported - Networkable

## Flexibility

- › Backbox with adaptations for 19" rack or semi flush mounting.
- › Most modules can simply be fitted in slot for ease of wiring
- › Optional battery capacities
- › Fast system set up and commissioning via the panel and commissioning tool



INSPIRE E10 2-8 Loop (HOP-131-206)



INSPIRE E15 2-8 Loop (HOP-134-412)

## INSPIRE E10 2-8 Loop (HOP-131-206)

- › Back box E10
- › 6 slot backplane (optional up to 10 slots)
- › 6.7A / 240W PSU
- › Door Including 10" Touchscreen
- › Charger Module
- › CPU Module
- › Notifier Dual Loop Module
- › Powerful ID<sup>2</sup>net Module
- › Fire/ Fault Routing Module
- › Serial COM Module (RS232/RS485)



## INSPIRE E15 2-8 Loop (HOP-134-412)

- › Back box E15
- › 2 x 6 slot backplane (Optional up to 14 slots)
- › 2 slot extension carrier
- › 10A / 480 W PSU
- › Door Including 10" Touchscreen
- › Charger Module
- › CPU Module
- › Notifier Dual Loop Module
- › Powerful ID<sup>2</sup>net Module
- › Fire/ Fault Routing Module
- › Serial COM Module (RS232/RS485)



## Mechanical Specification

Mounting Holes	5 (on backbox)
Cable entry holes (20mm)	30 (top), 17 (back), 26 (bottom)
External Connections	plug-in screw terminals 0.5mm <sup>2</sup> to 2.5mm <sup>2</sup> (14-22AWG)
Colour	RAL 7022, Semi-Gloss finish

### DIMENSIONS FOR IOU ENCLOSURE

Height	445 mm
Width	455 mm
Depth	190 mm with 8 mm spacers, 196 mm with 14 mm spacers

### DIMENSIONS FOR I5U ENCLOSURE

Height	665 mm
Width	455 mm

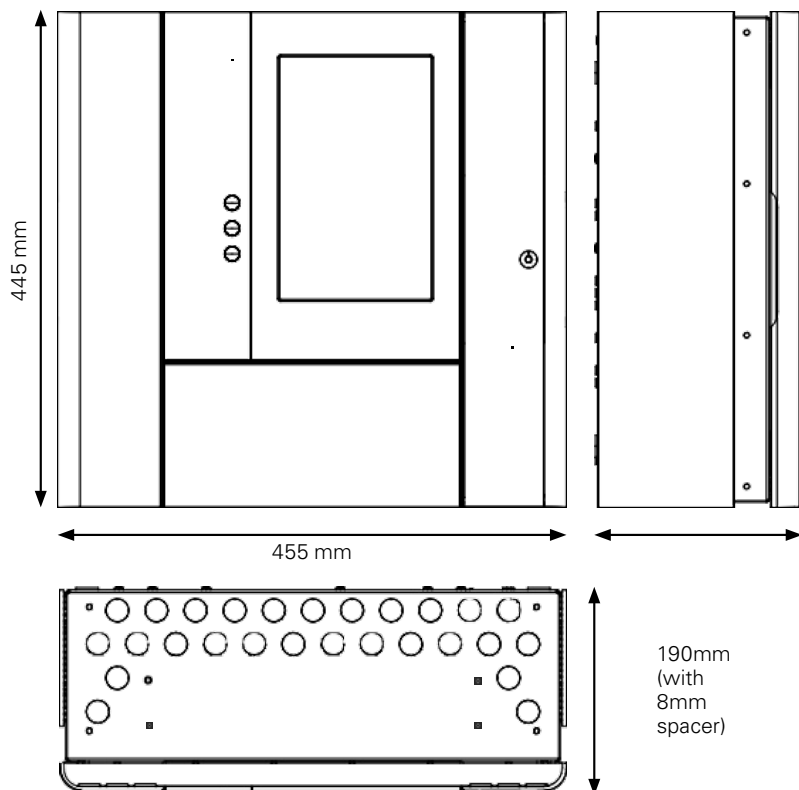

## Electrical Specification

Operating Voltage	230Vac 50Hz
Voltage Tolerance	-15%, +10% (195.5V to 253V)
Incoming Mains Fuse	3.15 A, T5AH / 250 V (20mm HRC anti-surge fuse in Mains terminal block)
Battery circuit inline fuse	25A
Mains input current	1.2 A for 240 W PSU, 2.3 A for 480 W PSU
Battery Charger Output Voltage	27.2 V nom @ 20°C (temperature compensated and current limited)
Power Supply Output Rating	36 V, 6.7 A for 240 W PSU 36 V, 13.3 A for 480 W PSU
Standby Batteries*	Min. 12Ah (24Vdc sealed lead-acid) Max. 24Ah (10U enclosure), 38Ah (15U enclosure)
Operating voltage range(s) for CIE's line voltage(s)	30 V (DC/DC converted -> independent from PSE status)
Operating voltage range for CIE's output	24 V ± 5 % DC, same at every Module

6

## Environmental Specification

Climatic Classification	3K5, EN 60721-3-3
Operating Temperature	0°C to +40°C
Relative Humidity	5% to 95% non-condensing
Panel Sealing	IP30 (EN60529)
EMC Emissions	EN61000-6-3
Immunity	EN50130-4
Safety	EN62368-1

## Mechanical Description

- › Side trim for surface mount (10U enclosure only)
- › All displays and controls are carried on the door.
- › Door is hinged on the left, opens using a 4mm hex Key
- › Door removable through fast clip hinges

\* YUASA NP range

## Inspire-EN Part Numbers

### CONTROL PANELS

HOP-131-206	Notifier INSPIRE E10 panel with 6-module slots, 240 W PSU / 6.7A, 10" display & Dual Loop module
HOP-134-412	Notifier INSPIRE E15 panel with 12-module slots, 480 W PSU/ 10A, 10" display and Dual loop module

### MODULES

HOP-433-100	Dual Loop Module OPAL (1 supplied and optional for extension)
HOP-631-100	ID2net Network Module (optional)
HOP-405-100	Serial COM Module (optional)
HOP-404-100	I/O Module 4CH AUX 24VDC (optional)
HOP-406-100	Fire/Fault Routing Module (optional)
HOP-407-200	Dual FBF/FAT COM Module (optional)
HOP-202-102	Back Plane 2 slot Module Carrier (option for extension)

### ACCESSORIES

HOP-238-110	Flush mounting kit for E10 panel. Recess dimensions 437mm (h), 462mm (w)
HOP-238-115	Flush mounting kit for E15 panel. Recess dimensions 660mm (h), 462mm (w)
HOP-208-111	Rack Mounting Kit
HOP-608-200	Net Converter Fiber Multi Mode

### SPARE PARTS

HOP-332-110	Door E10 10" HMI Notifier
HOP-332-115	Door E15 10" HMI Notifier
HOP-331-010	Door E10 Black Box Notifier
HOP-331-015	Door E15 Black Box Notifier
HOP-202-106	Back Plane 6 slot
HOP-202-210	Back Plane Interlink 2nd Row Modules Cable kit
HOP-502-120	Cable Kit Back Plane/Batteries
HOP-202-200	Back Plane Link Module for Module Carrier expansion (option for extension)
HOP-402-100	Charger Module (1 supplied)
HOP-431-100	CPU Module Notifier (1 supplied)
HOP-501-240	PSU 240W
HOP-501-480	PSU 480W

### BATTERY

NP38-12	38 Ah YUASA FR 12 V Sealed Lead Acid Battery (for an E15 enclosure only)
NP24-12	24 Ah YUASA FR 12 V Sealed Lead Acid Battery (for an E10 and E15 enclosures)
NP12-12	12 Ah YUASA FR 12 V Sealed Lead Acid Battery (for an E10 and E15 enclosures)



# Connected Life Safety Services (CLSS)

## **IT'S TIME TO EXPECT MORE FROM A FIRE DETECTION SYSTEM**

Honeywell CLSS is an innovative, all-in-one cloud-based platform that enables system integrators, service providers and facility owners to deliver an enhanced fire safety service, while maximising the performance efficiencies offered by Honeywell's trusted detection and alarm systems.

This level of sensitivity is comparable to EN 54-20 Class A Aspirating Systems and provides fast response to incipient fires combined with good nuisance alarm rejection.

# Connected Life Safety Services (CLSS)

## It's time to expect more from a fire detection system

Honeywell CLSS is an innovative, all-in-one cloud-based platform that enables system integrators, service providers and facility owners to deliver an enhanced fire safety service, while maximising the performance efficiencies offered by Honeywell's trusted detection and alarm systems.

## Productivity and fire safety enhanced with digitisation

System integrators and service providers across the fire safety are under pressure to achieve more with fewer resources whilst maintaining the highest levels of safety.

By adopting the CLSS platform, you will be more productive while keeping your customers safer:

- › **CLSS offers a deep insight into the maintenance portfolio\***. You will have knowledge of the device age, health, and status, enabling more efficient maintenance planning as well as real-time monitoring of system events such as fire/fault and disablements.
- › **Enables engineers to understand their next site visit before they arrive.** A detailed system status and site information can be viewed, increasing first time fix rates and maintenance performance.

- › **Key panel functionality in the palm of your hand.** Technicians can disable outputs, activate sounders, reset the panel, activate LEDs to confirm location, and even update device labels using their mobile phone.\*
- › **Device condition reports** are available at the touch of a button to assist the end-user with life-cycle costs.\*
- › **CLSS offers a remote consolidated view of a customer's systems.** Provides insight into the progress of maintenance activities against their plan with access to regulatory and non-regulatory reports.
- › **Quickly generate compliance reports.** Following inspection or maintenance visits, reports can be generated, shared and stored in the cloud for auditing purposes.

## Less disruption and enhanced compliance from your fire safety investment

Facility owners are under pressure to achieve more with fewer resources, yet they play a critical role in fire safety efforts and are seeking new solutions that provide peace of mind.

With CLSS, not only will your facility be safer and compliant, but your service provider will also serve you more effectively with less disruption to your busy schedule.

- › **CLSS ensures accurate forecasting of life-cycle costs for a fire system's service and maintenance.** By enabling predictive maintenance, site managers can spot and fix issues early before they result in unforeseen operational costs.\*
- › **Offers peace of mind that your systems are compliant.** With fast access to undisputable proof of compliance (aligned with mandated inspection and maintenance requirements), CLSS enables a full audit trail to be stored securely in the cloud.
- › **Real-time operational information.** CLSS enables site managers to react quickly to incidents and take appropriate measures.
- › **A holistic view of all your facilities.** Real-time details of significant events such as fire, faults/troubles and disablements, ensures that sites are operating effectively and meeting compliance requirements.
- › **CLSS is protected with extensive built-in cybersecurity provisions.** We are committed to pro-actively monitoring the cybersecurity landscape, ensuring data is safely stored and securely accessible to permitted system users.

\* Not available for Notifier ID3000 or Pearl panels. Coming via CLSS firmware upgrade for Notifier INSPIRE panels.

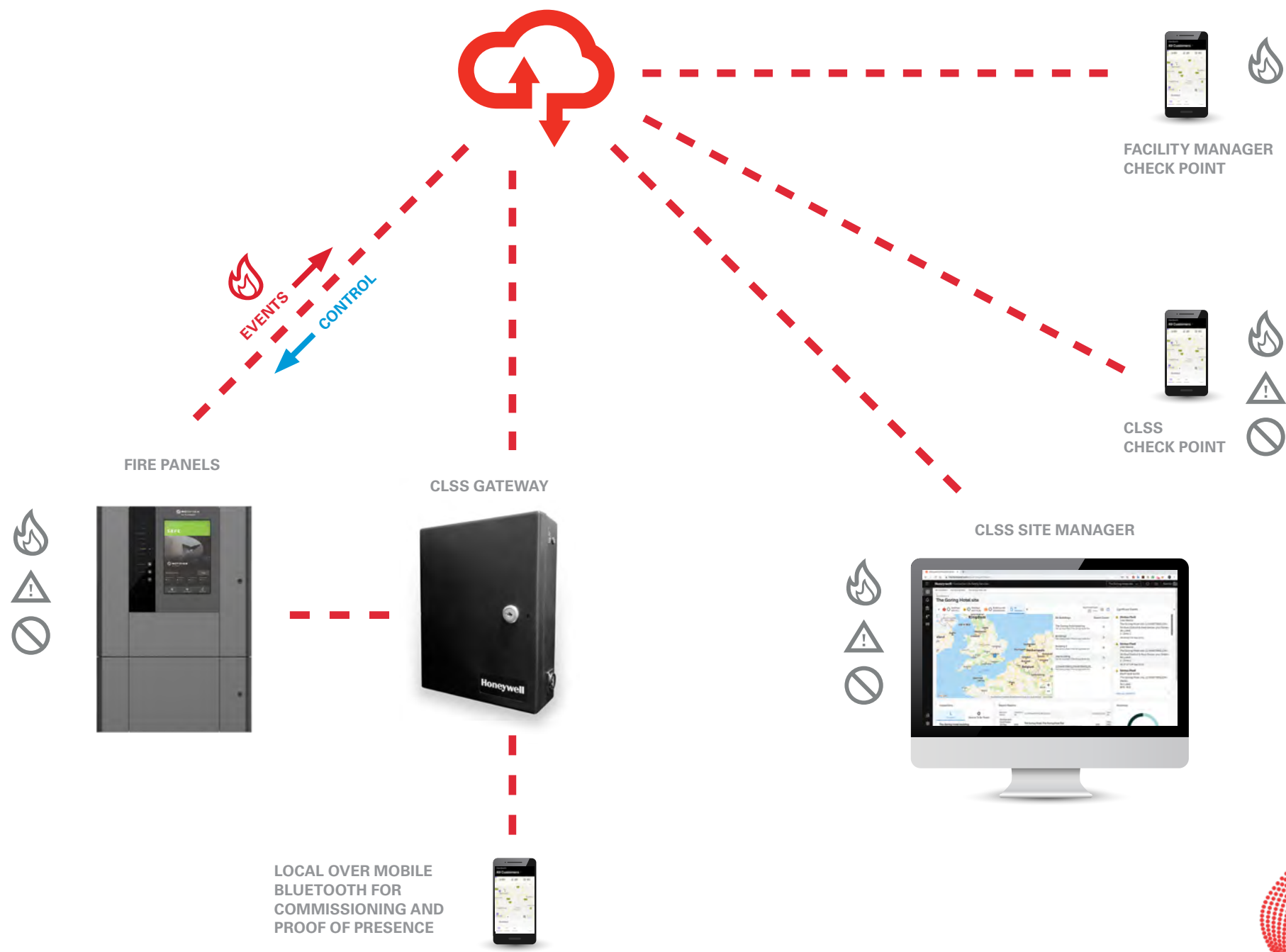



# High Sensitivity Point Detection

The high sensitivity LASER detector is wired on a standard fire alarm system loop and is similar to a normal point detector in appearance but internally it is very different. The standard LED found in a normal optical detector is replaced by high power output IR LED diode and precision optics technology, which is matched with a unique superior high gain IR receiver amplifier, enhancing the sensitivity of the device.

The chamber is supported by sophisticated processing circuitry and microprocessors that feature smoothing-filter algorithms to help eliminate transient environmental noise conditions, and reduce nuisance alarms.

The advanced detection capabilities are combined with co-operation detection where the control panel takes data from groups of sensors and makes a collective decision.

The result is a very sensitive but stable system that can achieve 0.07 to 6.5% / m obscuration sensitivity, providing up to 50 times more sensitivity than a standard photoelectric smoke sensor.

This level of sensitivity is comparable to EN 54-20 Class A Aspirating Systems and provides fast response to incipient fires combined with good nuisance alarm rejection.

# High Sensitivity Point Detection

## Very intelligent early warning

Three components make up the VIEW LASER point detection system. The intelligent control panel, VIEW high-power output IR LED sensors and the Advanced Signal Processing Software all work together to ignore unwanted signals caused by dust, electrical and electromagnetic interference whilst delivering sensitivity up to 0.07% obs./mtr without moving parts, pipes, fans or dust filters.

The system pinpoints the fire location and provides controlled stability, automatic drift compensation and adjustable alarm and pre-alarm settings. When placed within a cabinet, the sensitivity levels of 0.07% would detect an overheated resistor.

## Co-operating sensors

Point detection has a unique process called co-operation detection. Sensors within a similar area are grouped together and the Fire Alarm Control Panel then takes data from these grouped sensors and makes a collective decision.

This method of detection also provides a faster response as well as a good unwanted alarm deterrent.

## Dynamic intelligent grouping

The dynamics of this process is a rota that is continually updated with the five highest analogue values.

There is a pre-qualification to get into the Dynamic Intelligent Group which is 30% of the standalone threshold levels and as these levels change, the detectors are removed from this pool and replaced with the next highest value. This ensures that the co-operating algorithms are at their best at all times.

The five highest analogue values join the Dynamic Intelligent Group, which is continually updated. The joining threshold is 30% of the standalone alarm value.

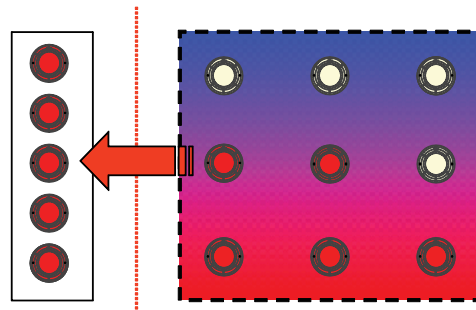

30% (variable due to air quality)

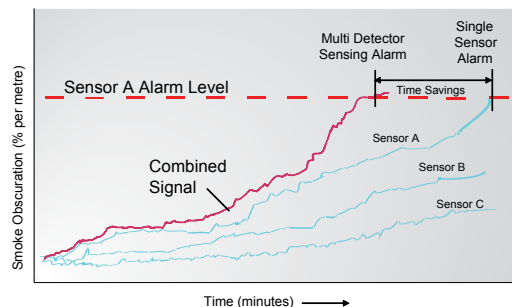

## Sensitivity adjustment

There are nine Alarm levels and eight Pre-Alarm levels, plus a Self-Optimising level. These can be independently set per detector and adjusted on a time base from the control panel. The Self-Optimising level is best suited to very high sensitivity levels and has to be conducted over a two-week soak testing period.

Pre Alarms – the ability to set thresholds at high sensitivities to give local audible and visual indication of impending alarms.

Alarm Levels – need to be configured in conjunction with the environment, i.e. if set too low would cause a nuisance value.

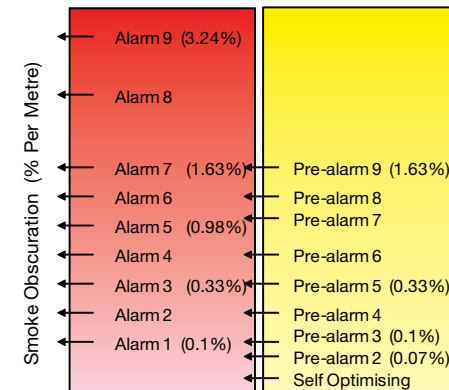

## System connection

Aspirating systems have to be linked to the fire system via interfaces and require a 24V supply to operate. If these links are broken or the PSU fails then the system is lost and the room may not be covered or be able to activate the main control panel.

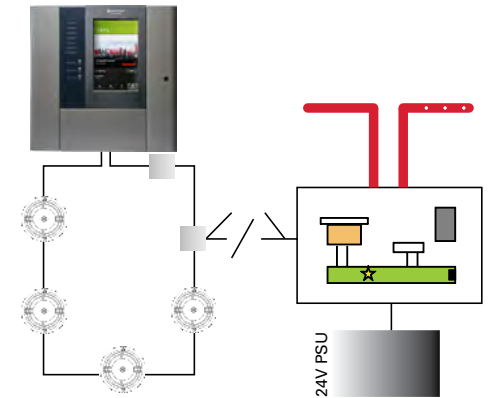

8

High sensitivity point detectors forming part of the loop, do not require a separate supply and have critical path redundancy, ensuring that the room is covered at all times. The sensitivity and reporting are all done at the control panel. Full addressability means the precise location of where the alarm has occurred can be identified.

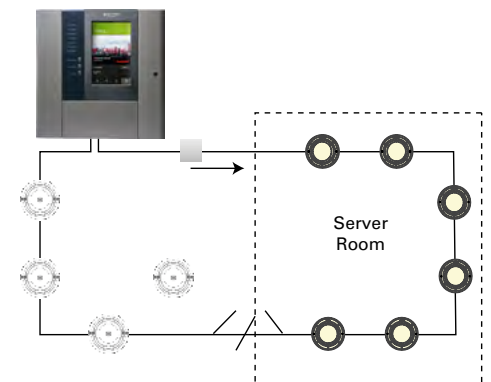

# High Sensitivity Point Detection

## System design

Both air sampling holes and detector spacings are the same and in accordance with BS 5839 and BS 6266 for both ASD and high sensitivity point detectors.

However, unlike ASD systems where the sensitivity of each sampling point varies depending on how many sampling holes are used, each high sensitivity point detector has a maximum sensitivity of 0.07% obs/mtr.

High sensitivity point detection and hole spacing on ASD systems can be designed to cover 100m<sup>2</sup> as per standard optical detector. However, due to the general environment in which these products are found, air velocity and change need to be considered and detector spacing will need further design input in line with BS 6266.

The faster or greater the air change, the higher the sensitivity of the detection system as the more velocity there is, the more smoke dilution there is. As a result, more detectors (or sampling holes for ASD systems) are required. A detection system that is more sensitive will detect smaller amounts of smoke quicker than a less sensitive detector that has a faster response.

If no local standards are applicable (e.g. BS 6266) the recommended coverage per sensor is 40m<sup>2</sup>. For very high air flow applications (over 10 air changes/hour), the recommendation is 25m<sup>2</sup> per sensor. This information is required in advance of design.

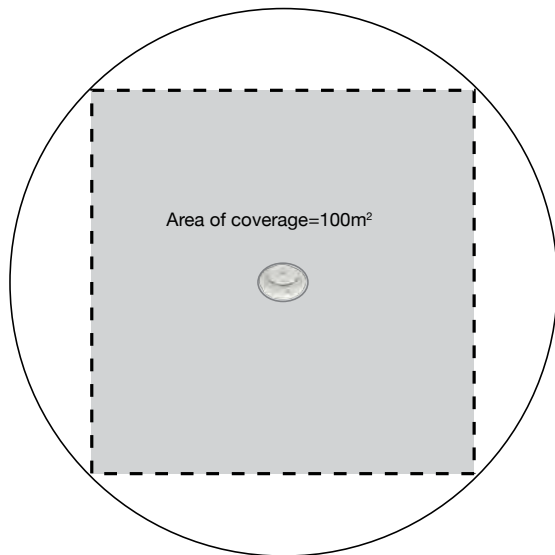

Standard detector spacing BS 5839 Pt 1

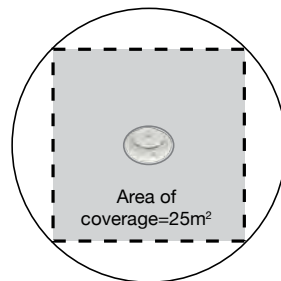

Laser detector spacing BS 6266 High Air Flow

Typical coverage with an airflow at greater than 10 changes per hr 25m<sup>2</sup>. Note that detectors are spaced so that the corners of the room are also protected.

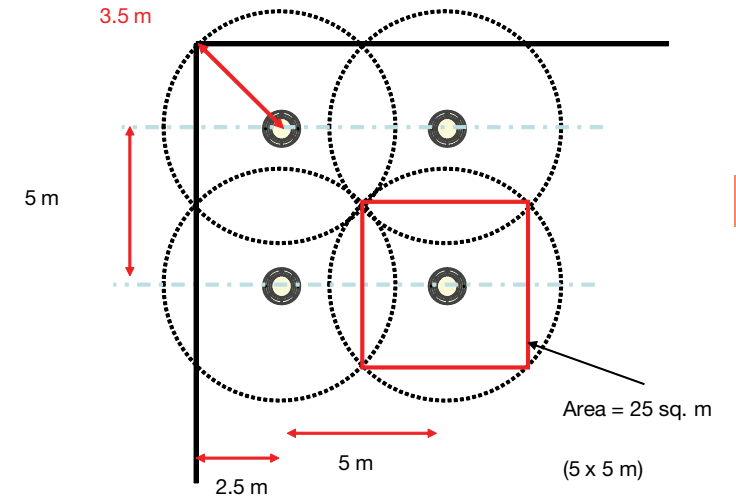



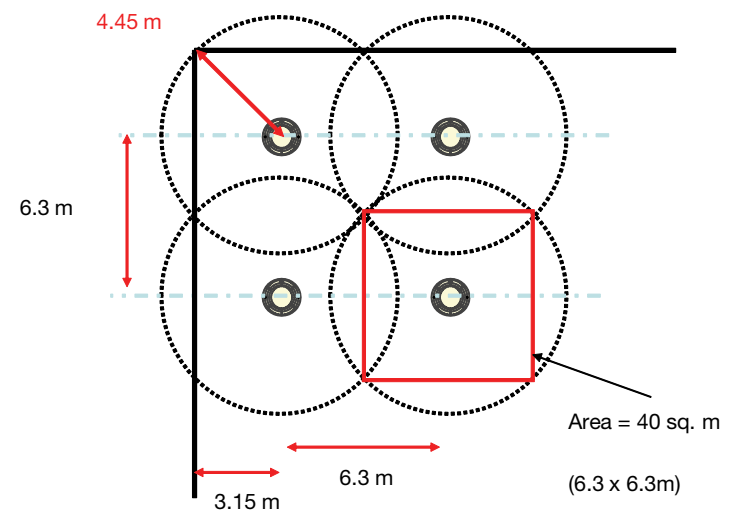













Typical coverage with an airflow less than 10 changes per hr at 40m<sup>2</sup> increased coverage. Note that detectors are spaced so that the corners of the room are also protected.



# Point Detection

## Product Range at a Glance

		Part Number
	OPAL Optical smoke detector	NFXI-OPT
	OPAL Optical smoke detector, built-in isolator, BLACK	NFXI-OPT-BK
	OPAL Heat detector, fixed 58°C	NFXI-TFIX58
	OPAL Heat detector (A1R), rate of rise + fixed 58C, built-in isolator, BLACK	NFXI-TDIFF-BK
	OPAL Heat detector (A1R), rate of rise + fixed 58°C	NFXI-TDIFF
	OPAL Heat detector, fixed 78°C	NFXI-TFIX78
	OPAL SMART2 Optical smoke and heat detector	NFXI-SMT2
	OPAL Optical smoke & heat detector, built-in isolator, BLACK	NFXI-SMT2-BK

		Part Number
	OPAL SMART <sup>3</sup> Optical smoke and heat detector with infra-red flame sensing	NFXI-SMT3
	SMART <sup>4</sup> Infrared, Carbon Monoxide, Optical, Thermal Multi sensor	IRX-751CTEM-W
	VIEW™ high sensitivity analogue addressable IR smoke detector, built-in isolator, with twin LED's, insect resistant screen, removable cover for field cleaning, direct decade 01-159 address entry, LED output and device blink option. Pure white.	NFXI-VIEW
	Analogue sensor base with SEMS screw connections and address identification label	B501AP
	Analogue sensor base with SEMS screw connections for isolated and non-isolated detectors and address identification label. BLACK.	B501AP-BK
	White deep analogue sensor base with built in relay, with SEMS screw connections and address identification number	B524RTE-W
	Base Sounder - Addressable loop powered base sounder, EN54-3 approved. WHITE. Built in loop isolation. (Manufacturing PN: BSO-PP-102)	NFXI-BS-W
	Base Sounder - Addressable loop powered base sounder, EN54-3 approved. BLACK Painted. Built in loop isolation. (Manufacturing PN: BSO-BB-102)	NFXI-BS-BK



# Beam Detection

This section aims to help the fire alarm system designer gain an understanding of the beam smoke detector's capabilities and limitations, and how they differ from point detectors.

Please note that this document is intended only as a general guide to the application of beam detectors. Reference should always be made to the detector manufacturer's installation requirements and instructions, and to BS 5839-1:2017.

Beam smoke detectors can be important components of a well-designed automatic fire alarm system. Their unique capabilities enable beam smoke detectors to overcome many of the problems and limitations of point detectors in some applications.

# Beam Detection

## Principles of operation

There are two basic types of projected light beam detectors, both of which operate on the principle of light obscuration: a light beam is projected across the area to be protected, and is monitored for obscuration due to smoke.

An End-to-End type detector has separate transmitter and receiver units, mounted at either end of the area to be protected. A beam of infrared light is projected from the transmitter towards the receiver, and the signal strength received is monitored.

Reflective or Single-Ended type detectors have all the electronics, including the transmitter and receiver mounted in the same housing. The beam is transmitted towards a specially designed reflector and the receiver monitors the attenuation of the returned signal.

The total obscuration of the light beam will normally be seen as a fault condition, rather than an alarm. This minimises the possibility of an unwanted alarm due to the blockage of the beam by a solid object, such as a sign or ladder.

Very small, slow changes in the quality of the light source due to dust and dirt accumulation are not typical of a smoke signature. These changes are typically compensated for by automatic drift compensation. The rate of compensation is limited to insure that the detector will still be sensitive to slow or smouldering fires.

## Accessories

Accessories to the beam smoke detector may include remote annunciators, remote test stations which allow for the periodic electronic testing of the detector, and filters used as a 'go/no go' test of the detector's proper calibration.

## Proper application

Like point smoke detectors, beam smoke detectors are inappropriate for outdoor applications. Environmental conditions such as temperature extremes; rain, snow, sleet, fog, and dew can interfere with the proper operation of the detector and cause nuisance alarms. In addition, outdoor conditions make smoke behaviour impossible to predict and thus will affect the detector's response to a fire.

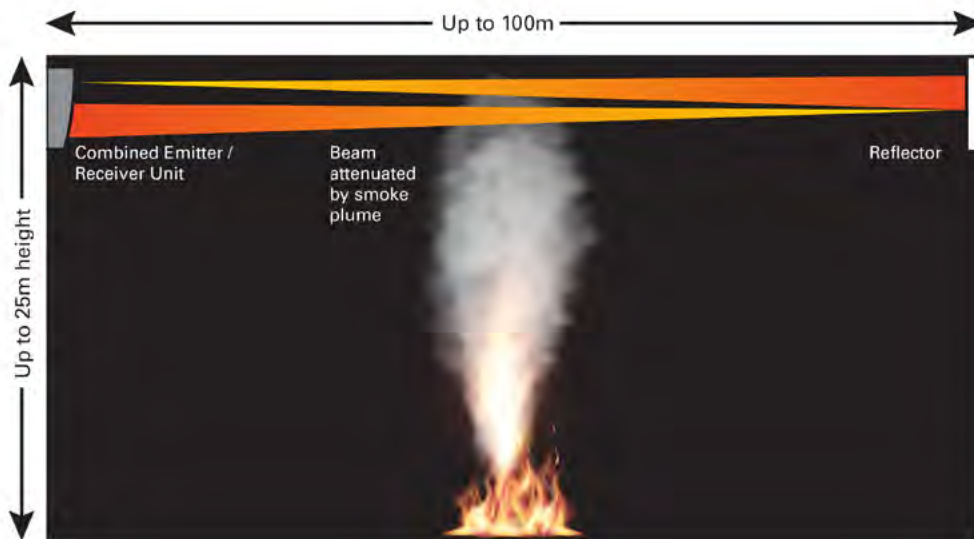

# Beam Detection

## Comparisons between beam detectors and point detectors

It is important that the fire system designer understands and gives full consideration to the differences in the principles of the operation of point and beam smoke detectors.

### Coverage

According to BS 5839-1:2017, a point smoke detector has a maximum radius of coverage of 7.5m. For a simple spacing plan as demonstrated below, this translates to a maximum distance between detectors of 10.5m. Careful manipulation of the detector layout, can reduce the number of point detectors required to cover a given area, however to cover large areas, many point detectors will be required.

For beam smoke detectors, BS 5839-1:2017 allows a maximum range of 100m, and coverage of 7.5m either side of the beam, thus giving theoretical area coverage of 1500m<sup>2</sup>, an area which normally would require sixteen or more point smoke detectors to cover. Reducing the number of devices used will lower installation and maintenance costs.

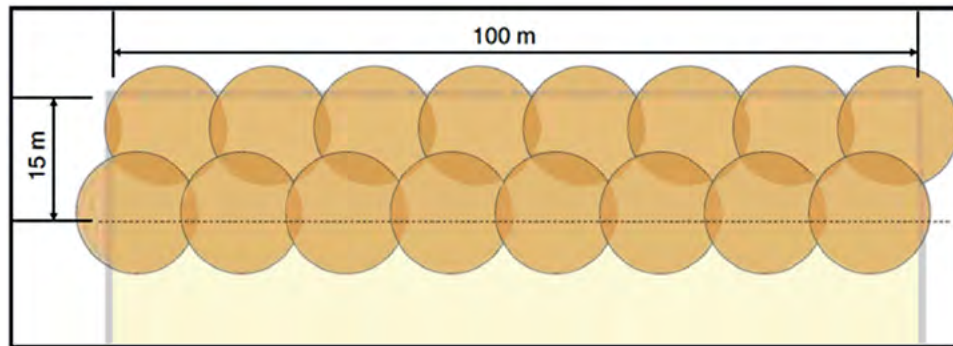

Point detector coverage over beam detector maximum area.

## Ceiling height

As a smoke plume rises, it spreads and becomes diluted. Point detectors tend to become less sensitive the higher they are mounted. BS 5839-1:2017 thus limits the mounting height of point detectors.

Beam smoke detectors are ideally suited to high ceiling applications since they can sample across the entire smoke plume. BS 5839-1:2017 permits the use of beam detectors up to heights of 40m for Category L or Category P systems.

In some applications, especially where high ceilings are present, beam smoke detectors may be more responsive to slow or smouldering fires than point detectors because they are looking across the entire smoke field intersecting the beam. Point detectors can only sample smoke at their particular 'spot'. The smoke that enters the chamber may be diluted below the alarm threshold (level of smoke needed for an alarm).

The major limitation of the projected beam smoke detector is that it is a line-of-sight device and is therefore subject to interference from any object or person which might enter the beam path. This makes its use impractical in most occupied areas with normal ceiling heights.

Many facilities have areas where beam smoke detectors are the detector of choice. High ceiling areas such as atriums, lobbies, gymnasiums, sports arenas, museums, churches, as well as factories and warehouses are good examples.

Many of these applications present special problems for the installation and maintenance of point detectors. Using beam detectors may reduce these problems since fewer devices may be required, and the devices can be mounted on walls, which are more accessible than ceilings.

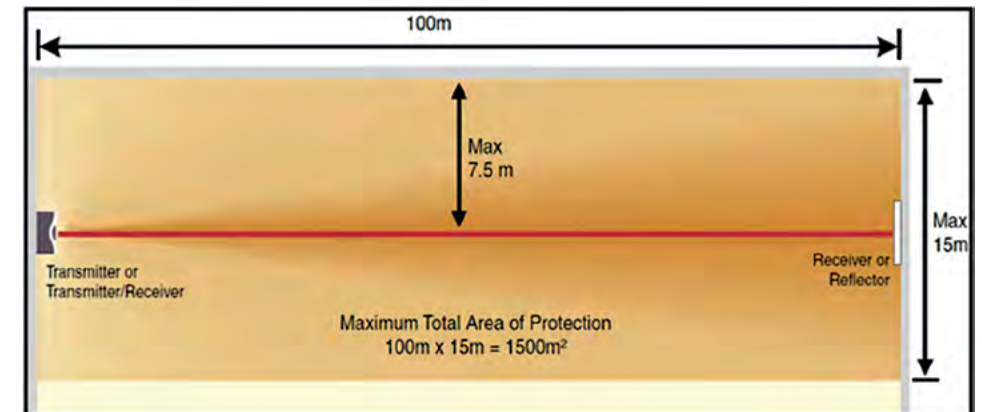

Maximum Area Coverage for Beam Detectors

# Beam Detection

## High air velocity

High air movement areas present a special problem for detecting smoke for both point and beam smoke detectors because the propagation of smoke developing under normal conditions may not occur. High air velocity may blow smoke out of the sensing chamber of a point detector. Careful consideration should be given to the point detector's performance where air velocities exceed 1.5 metres per second, or when air changes in the protected area exceed 7.5 changes per hour.

A beam smoke detector's sensing range can be as long as 100m, rather than the 50mm dimension of a point detector's sensing chamber. It is therefore less likely that smoke will be blown out of the beam smoke detector's sensing range.

Although reduced spacing is not required in high airflow areas, attention should be given to the anticipated behaviour of smoke in these applications.

## Stratification

Stratification occurs when the air within a room forms into layers at different temperatures; for example, the area just beneath an atrium's roof may be heated by sunlight, and create a layer of hot air above the main volume of the room.

Smoke is heated by the fire and rises through cooler lower layers until it reaches the warmer layer. It will not rise any further and will spread along the hot / cold boundary rather than the ceiling, possibly never reaching detectors mounted on, or near, the ceiling.

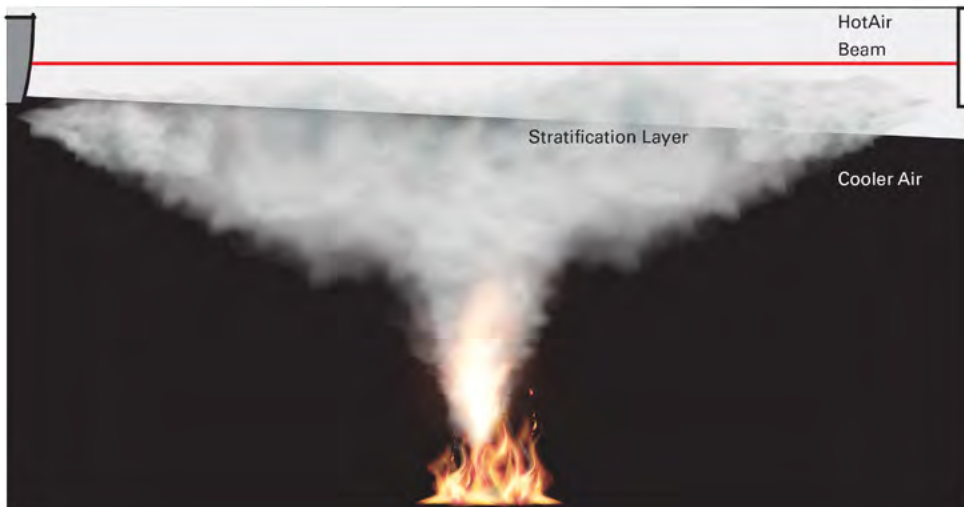

Effect of Stratification

Normally on smooth ceilings, beam smoke detectors should be mounted between 300mm and 600mm from the ceiling. However, the final location and sensitivity of the detectors should be subject to an engineering evaluation which is beyond the scope of this guide, but which will typically include structural features, the size and shape of the room and bays, occupancy and uses of the area, ceiling height, ceiling shape, surface and obstructions, ventilation, ambient environment, burning characteristics of the combustible materials present, and the configuration of the contents in the area to be protected.

## Hostile environments

One limitation of point smoke detectors is their vulnerability to hostile environments, such as extremes of temperature, dirt, humidity, and corrosive gases.

Beam smoke detectors may also be subject to some of these debilitating elements. While it is generally not recommended, a beam smoke detector can be placed behind clear glass windows outside the hazard, in order to overcome these effects. This feature may also allow them to be used in applications where explosion protection is required.

Barns and stables housing animals are good examples where early warning is required but where point smoke detectors may be unsuitable because of temperature extremes and dusty, dirty conditions. Beam smoke detectors offer an alternative because their optics can be kept behind windows that are easily cleaned on a regular basis. They may also have a much wider operating temperature range than point smoke detectors.

However, restrictions do apply: the glass must be kept clean and free of obstructions, and in the case of reflective type detectors, the beam must be placed at an angle to the window to prevent reflections from the glass causing incorrect signals. Consideration also needs to be made to the reduction in signal due to losses as the beam passes through the window. It may be necessary to reduce the maximum allowable beam length by up to 20% for a reflective type beam detector.

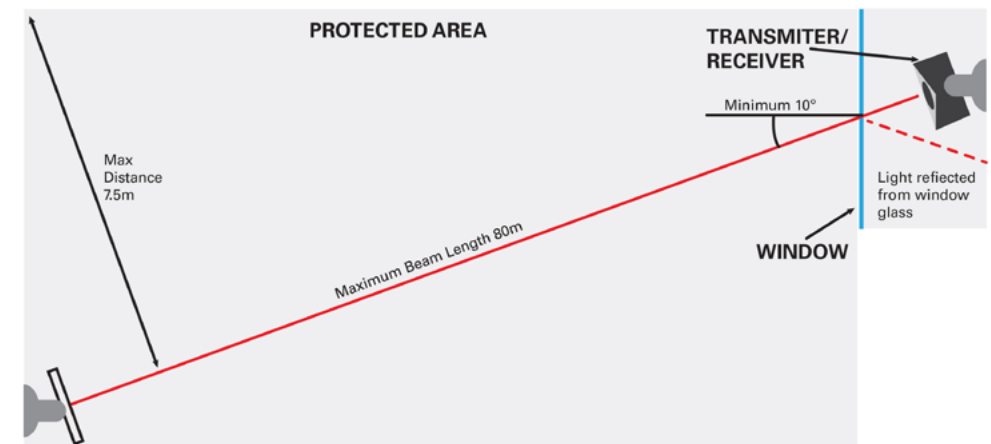

Reflective Beam Detector Operating through a Window

# Beam Detection

## Design requirements

Many factors affect the performance of smoke detectors of all types. The type and amount of combustibles, the rate of fire growth, the proximity of the detector to the fire, and ventilation factors are all important considerations. European approved beam smoke detectors are tested to EN 54-12:2002 Fire Detection and Fire Alarm Systems – Smoke Detectors – Line Detectors using an optical light beam. They should be installed and maintained in accordance with the manufacturer's requirements and in the UK BS 5839-1:2017.

## Sensitivity

The detector's sensitivity should be set with reference to the length of the beam used on a given application, combined with the environmental conditions at that location.

## Location and spacing

The following recommendations are based on BS 5839-1:2017. On a flat, unobstructed ceiling, the maximum distance covered by a beam detector should be 100m, or as per the manufacturer's recommendations if they are less. No point in the protected area should be more than 7.5m from the centre line of the detector beam. This gives a maximum spacing between two beam detectors of 15m, and a maximum distance from a wall to a beam detector of 7.5m.

Due to the large area it is possible to protect using a single beam detector, and care needs to be taken that search distance requirements are not exceeded. BS 5839-1:2017 recommends that the maximum distance travelled to visually locate a fire within a fire zone should be 60m. Where a

beam detector is used to protect, for example, a large warehouse with racking and partitioning, it would be easy to exceed this requirement.

## Pitched roofs

When a roof is pitched, smoke tends to roll quickly up the slope of the roof, and collect into the apex. Therefore, if a detector is to be mounted on a pitched ceiling, having a rise height of greater than 600mm, a detector should be mounted at or within 600mm of the apex of the roof. Where the sloped area of the roof is long enough, the distance from the detector at the apex of the roof to the next detector may be increased from 7.5m at a rate of 1% per degree of slope, up to a maximum of 25%. If the rise is less than 600mm the slope should be ignored and the roof treated as flat. Note that this increased coverage applies only to detectors fitted at the apex of the roof; standard spacing applies to all other detectors.

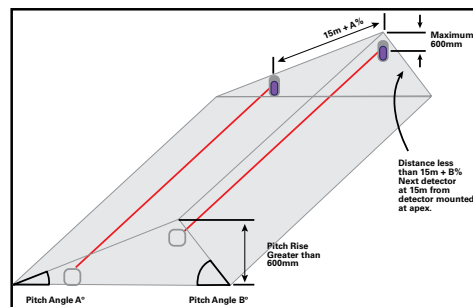

For example, up to 18.75m width can be covered by one optical beam detector mounted within 600mm vertical of the apex, using the extra coverage of 25% given by a roof angle of 25°.

## Obstructions

Obstructions on or near the ceiling or on the walls of a protected area will affect smoke distribution, and thus need to be taken into consideration during the fire protection system design.

Ceiling obstructions such as joists greater than 10% of the total room height should be treated as a wall, and thus the areas on either side should be treated as separate rooms. Similarly, if partitioning or racking is closer than 300mm to the ceiling, they offer a significant obstruction to the distributions of smoke and should be treated as walls.

For rooms with a number of joists or structural beams, the detector beam should be run parallel with the joists. Depending on the depth of the joists, the area that the detector can protect either side of its beam may be affected.

Beam detectors should not be mounted so their optical beam runs any closer than 500mm to any wall or obstruction such as ducting or structural beam. Some types of beam detector use a wide beam, and these may require a greater spacing than 500mm from any obstructions.

Obstructions will inhibit the free flow of smoke within a room and thus affect the detectors ability to detect a fire. When an obstruction is reflective, spurious signals may be reflected back to the receiver and distort the detector's response.

This can lead to nuisance alarms or the detector

failing to detect a fire. Therefore, all reflective surfaces should be a minimum distance (e.g. for Notifier Opal beam detectors – 380mm) from the centre line of the detector beam. In fact, it is good practice to ensure that the spacing from the beam centre line is applied to all objects.

## Beam blockage

Optical beam detectors are line-of-sight devices, and rely on a clear path between the transmitter and receiver or reflector. If the beam is blocked, then the detector cannot detect a fire. Care must therefore be taken that the beam is not mounted where it could become blocked during normal operation.

If people are likely to be present in the protected area, then the detector should be mounted a minimum of 2.7m above floor level. Other possible causes of beam blockage including forklift operation, for example, should also be considered.

## Supplementary detection

In areas with relatively high ceilings, for example, an atrium, supplementary beam detectors can be used to provide earlier warning of a fire, or to help guard against the effects of stratification.

However, since they are not subject to the spreading effect of a ceiling on a plume of smoke, the beam spacing should be reduced. BS 5839-1:2017 recommends that supplementary beam detector cover should be 12.5% of the height of the beam above the highest likely seat of a fire to either side of the detector beam.

# Beam Detection

## Building movements

One of the major considerations when siting beam detectors is the effect of the movement of the building as it is subjected to various environmental forces. Wind, snow, rain and temperature can all cause a building to flex. Over longer ranges, even slight deformations of the mounting structure can cause the beam to move considerably from its target – over a 100m range, a movement of 0.5° at the transmitter will cause the centre point of the beam to move nearly 900mm.

In order to minimise possible false alarms or fault signals caused by building movement, the beam detector must be mounted on solid parts of the building such as the main support pillars. They should never be mounted on easily deformed sections such as metallic cladding. If it is not possible to mount both components of the detector onto solid construction, then the transmitter should be fixed to the more solid surface, since movement will affect the receiver or reflector less than the transmitter.

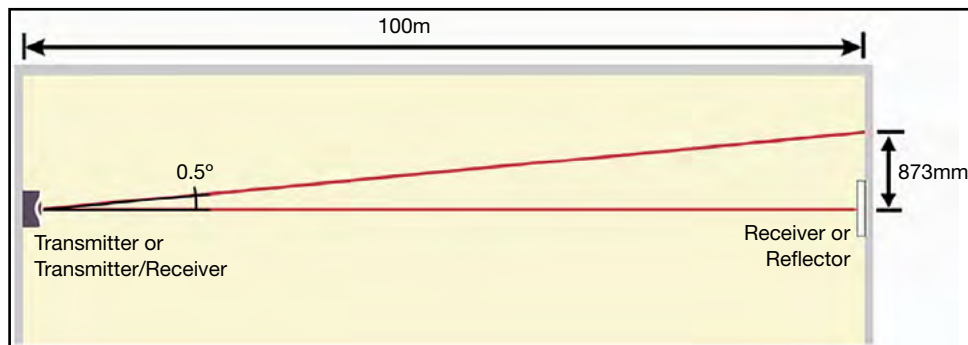

Effect of Detector Movement

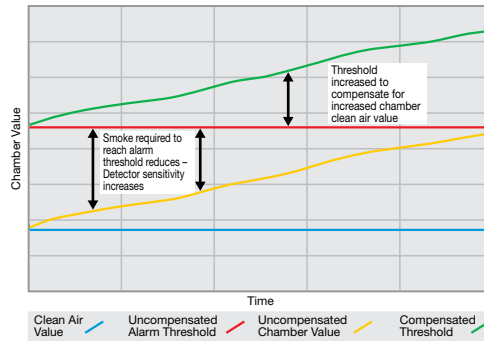

## Testing and maintenance

As dust builds upon a beam detector's optical components, its sensitivity will increase, leading to an increased susceptibility to nuisance alarms. Most modern beam detectors include algorithms to compensate for this gradual build up of dirt and reduce maintenance whilst retaining constant sensitivity, however, the detector lenses and reflector will still need to be cleaned periodically. The maintenance interval will be dependent on site conditions.

## Maintenance

Manufacturer's instructions should be referred to for cleaning procedures, however, a fairly typical maintenance method is to clean the detector lenses and reflector with a damp soft cloth and a mild soap. Solvents should not normally be used.

Note: Before carrying out any maintenance on the detector, notify the relevant authorities that the fire detection system is undergoing maintenance, and that the system is therefore temporarily out of service. Disable the relevant zone to prevent unwanted alarms.

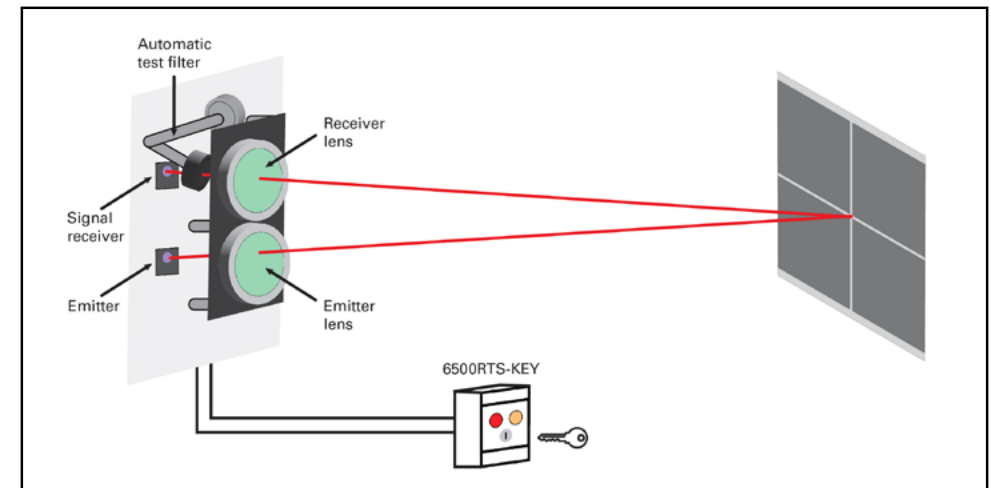

Notifier Opal Beam Detector remote test operation

## Functional testing









Following installation, or any routine maintenance work, beam detectors should undergo functional testing. The normal means of testing a beam detector is to place a filter in the path of the beam to reduce the amount of received light below the detector threshold and thus produce an alarm.

With the Notifier Opal Beam detector, a graduated scale is marked on the reflector. To test the sensitivity, a suitable piece of opaque material is used to block off a section of the reflector corresponding to the sensitivity, checking that the detector reacts as expected.

The Notifier Opal Beam detector also incorporates a remote test feature. On command from a remote station, a calibrated filter is moved in front of the receiver, simulating the effect of smoke on the beam. If the correct signal reduction is detected then the detector will enter the alarm condition, otherwise a fault is returned. This function meets the periodic maintenance and testing requirements of most local standards providing a complete check of every component in the alarm path without the need for access at high level. Opal Beam with test facility requires an external 24v supply to activate.

# Beam Detection

## Product Range at a Glance

		Part Number
	Loop powered reflective IR beam, complete with reflector for up to 70 metres. Use BEAM-LRK for 70 to 100 metres.	NFXI-BEAM-E
	Loop powered reflective IR beam with servo test feature, complete with reflector for up to 70 metres. Use BEAM-LRK for 70 to 100 metres.	NFXI-BEAM-TE
	Surface Mount Kit for IR reflective beam. Allows direct surface cable entry.	6500-SMK
	Multi Mount Kit for IR reflective beam. Provides ceiling and wall mount swivel bracket. Note: requires BEAM-SMK.	6500-MMK
	Long range reflector kit for 70 to 100 metres.	BEAMLRK
	Remote test key switch for beam detectors	6500RTS-KEY
	Heater kit for beam unit	BEAMHK
	Heater kit for reflector unit	BEAMHKR



# Open Area Smoke Detection (OSID)

As an alternative to traditional beam detection, Open Area Smoke Image Detection (OSID) is a viable alternative. Key advantages to the OSID range are that they are less sensitive to unwanted alarms caused by:

- › Building vibration and movement
- › Sporadic physical barriers i.e. ladders, cherry pickers and forklift trucks
- › Insects and birds
- › Dirt, dust and steam
- › Reflective and direct sunlight

# Open Area Smoke Detection (OSID)

Large, open spaces – warehouses, airports, train stations, stadiums and shopping malls – pose unique challenges to reliable fire detection due to their environmental nature and limitations.

Open Area Smoke Image Detection (OSID) is a new innovation in projected beam smoke detection technology. By using advanced dual wavelength projected beams and optical imaging technology for early warning smoke detection, OSID provides a low-cost, reliable and easy-to-install solution that overcomes typical beam detection issues such as false alarm incidents and alignment difficulties.

## OSID configurations

OSID systems may be configured to protect a range of spaces, regardless of shape. The protection zone or 'fire web' is determined by the placement of OSID detectors. Multi-emitter solutions provide a true 3D arrangement.

## Superior features offered by OSID

- › Patented dual wavelength, UV and IR, particle detection
- › CMOS imager with wide viewing angles
- › Simple installation, commissioning and maintenance – up to 70% time saving compared to traditional beams
- › High tolerance to vibration and structural movement and high airflow
- › High resistance to dust, fogging, steam, reflections and object intrusion
- › High resistance to reflected sunlight
- › Requires as little as 20 x 20 cm (8x8") unobstructed width of view
- › On-board log memory for fault and alarm diagnostics
- › Software tool for diagnostic purposes
- › Aesthetically discreet and 3D coverage
- › Long range up to 150 m (492 ft)

## Unique detection technology

The OSID system measures the level of smoke entering beams of light projected over an area of protection.

A single OSID Imager can detect up to seven Emitters to provide a wide coverage area.

Two innovations in smoke detection technology have been developed for the revolutionary OSID smoke detector:

## Dual wavelength particle detection

The beam projected from each emitter contains a unique sequence of ultraviolet (UV) and infrared (IR) pulses that are synchronised with the imager and enable the rejection of any unwanted light sources. By using two wavelengths of light to detect particles, the system is able to distinguish between particle sizes. The shorter UV wavelength interacts strongly with both small and large particles while the longer IR wavelength is affected only by larger particles.

Dual wavelength path loss measurements therefore enable the detector to provide repeatable smoke obscuration measurements, while rejecting the presence of transient dust particles or solid intruding objects.

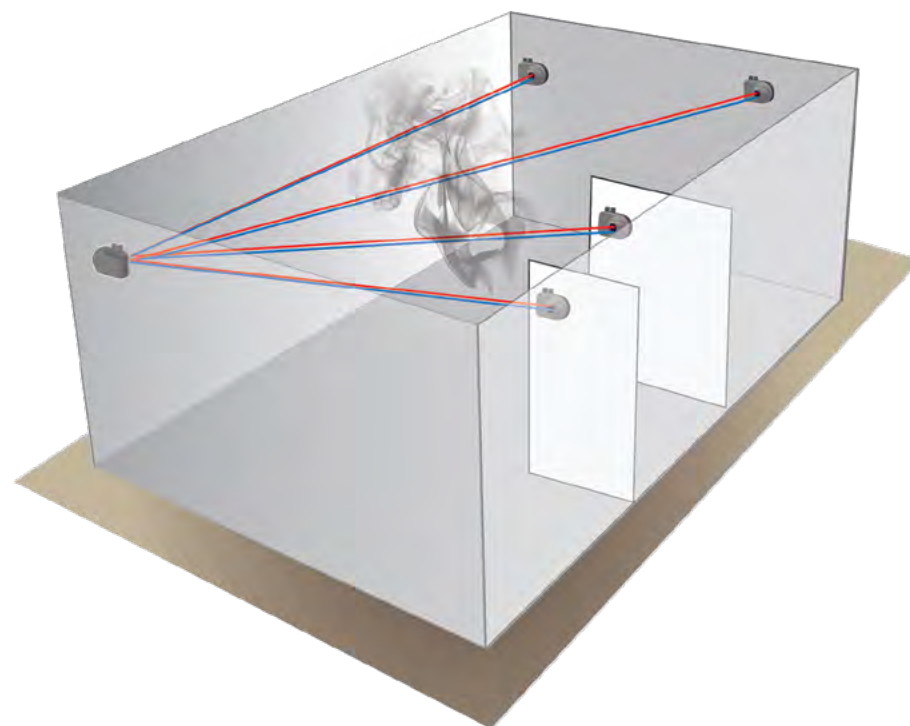

10

## Optical Imaging with a CMOS Imaging Chip

An optical imaging array in the OSID Imager provides the detector with a wide viewing angle to locate and track multiple Emitters. Consequently, the system can tolerate a much less precise installation and can compensate for the drift caused by natural shifts in building structures. Optical filtering, high-speed image acquisition and intelligent software algorithms also enable the OSID system to provide new levels of stability and sensitivity with greater immunity to high level lighting variability.

## OSID Reflective Imaging Smoke Beam Detector

The OSID range of open area smoke detectors deliver a great package for reliable smoke detection in large or open spaces. With the use of CMOS imaging technology, OSID not only provides reliable smoke detection but has been designed for rapid installation and reliable operation during the lifetime of the detector. No longer are installers faced with lengthy and costly installation processes and call backs; and End-Users are no longer disturbed by nuisance or false alarms associated with building movement; dust or beam interruption. OSID offers a reliable alternative to heat or flame detectors, which typically initiate much later in the fire development cycle.

### 3D Volumetric Coverage

A significant benefit of OSID is its ability to provide volumetric coverage. As many as seven emitters can be placed within the field of view of a single imager, each placed at different heights. The OSID imager's large viewing angles, both horizontal and vertical, enable three-dimensional area coverage for design flexibility and additional deployment savings. Unlike other volumetric technologies, OSID delivers absolute calibration for consistent detection performance regardless of lighting conditions, smoke color, airflows or other environmental conditions.



### OSID-DE

Next to this step-in model, there is OSID-DE (Dual-Ended) that uses a similar CMOS sensor with wired or battery-powered emitter(s) roughly aligned on the opposite wall within the protected area. The emitter sends both infrared and ultraviolet coded light signals to the imager. The innovative use of dual light frequencies in an open-path device enables OSID-DE to discriminate between real smoke and other solid objects. It offers a high resistance to sudden and transient dust and steam clouds, thus drastically reducing false alarms.







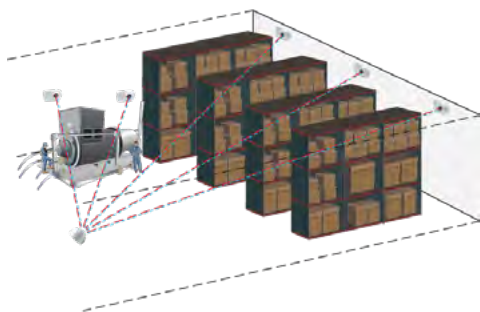





### NFXI-OSI-RI

New in its simplest configuration, OSID-R (Reflective) uses an imager and a reflector. It operates on the principle of light obscuration, utilising an infrared beam and smart analysis on the pixel level of its reflector, offering superior performance. Power and connectivity occur in the imager only, and the OSID-R only requires a single standard reflector on the opposite wall (and not a larger reflector the further the distance).





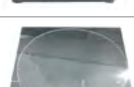







# Open Area Smoke Detection

## Product Range at a Glance

	Part Number
	Imaging smoke beam smoke detector including reflector OSI-RE-SS
	Imager – 7° coverage OSI-10
	Imager – 80° coverage OSI-90
	Emitter - Standard Power Alkaline Battery OSE-SP-01
	Emitter - High Power Alkaline Battery OSE-HP-01
	Emitter – High Power, Wired OSE-HPW
	Emitter – Standard Power, Wired OSE-SPW
	Emitter environmental housing IP66 OSID-EHE
	Anti-condensation film for Emitters OSE-ACF
	Anti-condensation film for OSID-EHE and OSID-EHI environmental housings OSEH-ACF

# Open Area Smoke Detection

		Part Number
	Imager environmental housing IP66	OSID-EHI
	FTDI Cable 1.5m	OSP-001
	Laser Alignment tool	OSP-002
	OSID Installation Kit	OSID-INST
	Spare alkaline battery pack for Emitter units	OSE-RBA
	Wire Guard	OSID-WG
	Acrylic test filter - 10 pack	OSP-003
	Acrylic test filter - bulk pack 200 units	OSP-003-200
	Test and reset station for flush mount	RTS151KEY

		Part Number
	Test and reset station for surface mount	RTS151 KIT
	Heater kit for the reflector	BEAMHKR

# Air Sampling Detection

## ASD system applications

To protect people, mission critical facilities and high value assets from the faintest traces of smoke, in a wide range of challenging environments.

## Mission critical

For these environments, there is no downtime. Every second lost, every transaction missed, any data or equipment destroyed can mean huge financial losses. High sensitivity aspirating systems alert facility managers hours, even days, before the first indication of system trouble – helping them keep their mission critical facilities up and running 24/7 and preventing unnecessary activation of suppression systems.

## Discrete detection

When aesthetics matter, such as in museums, churches or mansions, an aspirating system provides a discrete smoke detection solution that is nearly invisible to the public. At the same time, it provides the earliest and most accurate smoke detection available to protect high-value items from fire.

## Restricted access

Some fire systems must protect areas such as prisons and public spaces, where there is a concern for tampering. An aspirating system can be mounted in a secure area while air sampling points are located in the protected environment, minimising the potential for tampering.

## Difficult environments

Some areas, like cold storage facilities, high bay warehousing or wash down areas (food preparation) have environmental conditions outside the tolerance of typical fire detection

technologies. Aspirating units can be mounted at an accessible location at low level or, where access is an issue, outside of the protected area, while sampling points can be located within the environment, enabling ease of maintenance.

## Data and remote connectivity

The ASD system from Notifier provides you with the data you need to manage your environment. It includes four alarm levels and fault indication with VESDA touchscreen display, full smoke level, fault type indication and airflow readings per active pipe are displayed, or through a variety of remote devices.

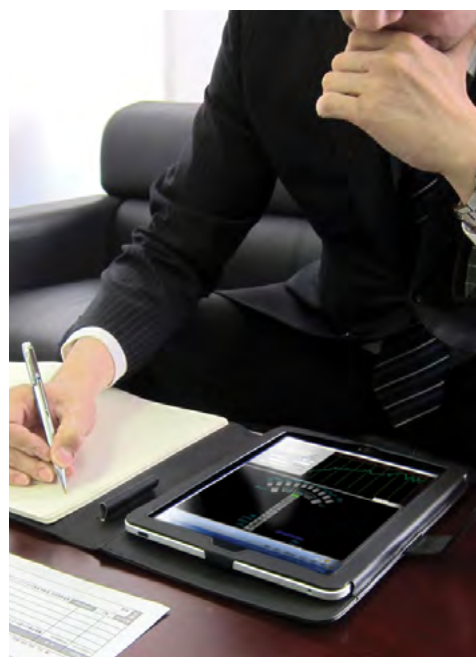

## High sensitivity ASD systems

Aspirating Smoke Detection (ASD) systems can detect fires at a very early stage, often before visible smouldering takes place, before an open fire occurs and before intense smoke develops. This early detection is vital to mission critical and high-risk applications such as EDP areas, internet data centres and network operating centres. Such areas typically have an increased fire risk due to high power requirement and density of equipment.

The earliest possible fire detection brings significant time benefits, enabling a fast response to the first signs of smoke.

## EN 54-20 sensitivity classes

Smoke detector sensitivity is normally defined in terms of 'percentage obscuration per metre' (%obs./mtr) – that is to say, the amount of smoke required to obscure the passage of light by a given percentage across a distance of one metre.

The EN 54 Part 20 Code of Practice defines three sensitivity categories for smoke detection systems:

- › **CLASS A**  
Very High Sensitivity, used where very early warning fire detection is required. Designed primarily for high-risk areas and where high levels of air conditioning and air dilution exist.
- › **CLASS B**  
Enhanced Sensitivity, very early fire detection for most areas in which valuable goods and/or processes need to be protected.
- › **CLASS C**  
Normal Sensitivity, for general fire protection applications.

## Approaches to achieve EN 54 Part 20 Class A sensitivity air sampling detection

ASD systems draw air samples continuously from the monitored area through a pipe system fitted with sampling holes at regular intervals. The sampled air is then analysed for smoke particles and an alarm is raised if smoke is present and reaches the pre-determined smoke concentration level.

# Air Sampling Detection

## Monitored area

The sampling holes in the monitored area are arranged so that the same amount of air is drawn through each hole. Each sampling hole is therefore allocated the same monitored coverage as a point-type smoke detector.

## Cumulative effect

A cumulative effect is achieved by having multiple sampling holes in a room. Each sample hole will take in small samples of smoke as it spreads across the protected area. This cumulative smoke is therefore delivered to the detector as the sum of each of the sample holes within the risk.

This enables the ASD system to give a much earlier indication of a developing fire at the incipient stage.

## High false alarm immunity

The physical separation of the detection unit from the monitoring area reduces the risk of transient faults such as those caused by condensation and electromagnetic radiation. The use of filters and the appropriate signal processing also guarantee reliable detection in dusty conditions.

## Maximum coverage

The maximum coverage of an ASD system is determined by the number of point-type detectors than can be replaced by an ASD device. This is a crucial factor in determining what savings can be made by installing an air sampling system. The coverage can be worked out simply by calculating how many sampling holes can be installed at a reasonable distance from each other (that of a point detector).

## British Standards

In addition to EN 54-20, ASD systems should be designed and installed in accordance with the FIA Code of Practice, BS 5839-1:2017 and BS 6266:2011 where relevant.

**BS 5839-1:2017** – Used when the design mimics that of standard detection. ASD systems are used to directly replace point or other conventional detection methods for practical, environmental and/or financial reasons.

**BS 6266** – Used when installing ASD systems with Electrical Equipment such as IT/ Communication suites. Again, design mimics that of traditional detection; however, the use of high sensitivity systems are encouraged and in some cases demanded.

## Designing EN 54-20 compliant systems

If an ASD device has been correctly classified as Class A, B or C, this does not necessarily mean that it will satisfy the class specified in the project design. Labelling a device with a detection class simply indicates that a minimum project design with a single sampling hole corresponding to the specified class can be implemented. It is therefore important to check that the entire project design satisfies the desired detection class.

This can be done by the use of software supplied by ASD system manufacturers. The software takes into account the configuration options within the scope of the defined project design limits. The software should produce a conformity declaration for the detection categories specified by the selected project design in accordance with EN 54-20.



10



# Air Sampling Detection

## Pipe systems

### ABS PRESSURE PIPE SYSTEMS

ABS (Acrylonitrile Butadiene Styrene) is a homogenous material with good chemical resistance and high impact strength.

Another benefit is its suitability for use at low temperatures (-40°C) and its ease of jointing.

### STANDARDS

Individual products should be in accordance with the appropriate British Standards:

- › Fittings (Metric) Din 8063, Kiwa 549, ISO 727
- › Pipe BS 5391 EN 61386-1 Class 1131
- › Adhesive BS 4346 Part 3

## Technical – jointing guidelines

Solvent cement is specially formulated to chemically weld pipes and fittings together. The solvent cement chemically melts the two surfaces to be joined, so that when they are fitted together they form a homogenous mass, which then cures to form a weld. Note that this is not a glued joint.

It is therefore important to choose the correct type of adhesive as another type may be detrimental to the integrity of the system.

1. Cut the pipe at right angles to its axis, and to the required length using the correct cutting shears.
2. Dry fit the pipe to the socket of the fittings. When the pipe is fully home in the socket, draw a line around the pipe at the edge of the socket. Where this is not possible (perhaps on larger fittings) measure the socket depth and draw a line at the corresponding point along the pipe. This will give a visual indication, to ensure that the pipe is fully pushed home in the socket.

3. Apply the solvent cement with a suitably sized brush or the brush provided in the adhesive lid. Ensure that the area of the pipe up to the visual indicator is completely covered with an even layer of cement. This part of the operation must be done quickly and neatly, as the solvent must still be wet when the pipe and fitting is pushed together.
4. Push the pipe and fittings together and hold in place for up to 30 seconds. When the joint is made, a bead of solvent cement will form around the outer joint of the pipe and socket. This excess cement should be wiped away leaving the outer part of the joint clean.

### JOINTING 'DON'TS'

- › Don't make joints in rain or wet conditions.
- › Don't use brushes or cleaning rags, which are dirty or oily.
- › Don't use the same brushes with different solvent cements.
- › Don't dilute or thin solvent cements with cleaner.
- › Don't leave solvent cement tins open. The contents will evaporate and the cement performance will be weakened.
- › Don't use near naked lights, or smoke whilst jointing. Solvents are highly inflammable.
- › Don't make joints in a confined space. Solvents emit hazardous vapours, which are dangerous.

### JOINTS PER LITRE OF CEMENT

As a rule of thumb, around 70 joints can be made per 250ml of solvent cement when jointing 25mm ABS fittings and pipe.

## Expansion and contraction

Expansion or contraction of the plastic pipe is caused by temperature change occurring within the pipe wall. When the operating temperature of a pipe is greater than when it was installed, then the pipe will expand. If the operating temperature is lower, then it will contract.

There are two factors to consider when calculating expansions or contractions in pipes:

1. Ambient temperature of the (air temp) environment when installing the pipe.
2. Change of temperature of pipe contents or environment.

Any change in the above factors will affect the mid-wall temperature of the pipe, thus causing either expansion or contraction.

Note that most pipework systems are installed between 5°C and 25°C. Co-efficient of Linear Expansion for Plastics.

### CALCULATING EXPANSION/CONTRACTION

- a. The change in length due to contraction or expansion in a pipe system is determined by the following formula:

$$\Delta L = \Delta T \times L \times \alpha$$

Where  $\Delta L$  Expansion ( $\Delta L_e$ ) or contraction ( $\Delta L_c$ ) in mm

$\Delta T$  Difference in temperature between the installation and the operating temperatures in °C (= T operate - T install)

L Length of pipe when installed

$\alpha$  Relevant coefficient of expansion (ABS will expand 0.100mm per metre, for every 10°C raised in mid-wall temp above the installation temperature)

### Example:

Find the expansion and contraction on a 25mm diameter ABS pipe system, installed at 10°C. The maximum and minimum operating temperatures are 30°C and 8°C respectively. The overall length of the installation is 30m.

1. Calculate temperature change for expansion and contraction:

$$\Delta T = 30 - 10 = +20^\circ\text{C}.$$

$$\Delta T = 8 - 10 = -2^\circ\text{C}.$$

2. Now calculate expansion and contraction,

Expansion:

$$\Delta L_e = \Delta T \times L \times \alpha = 20 \times 30 \times 0.100 = 60\text{mm}$$

Contraction:

$$\Delta L_c = \Delta T \times L \times \alpha = -2 \times 30 \times 0.100 = -6\text{mm}$$

3. In order to provide for the correct solution, it is necessary to take the greater value, regardless whether it is due to expansion or contraction. i.e.  $\Delta L = 60\text{mm}$ .

### HOW TO ALLOW FOR EXPANSION OR CONTRACTION

The change of length in a pipe system, whether it is expansion or contraction, will require compensation, so that any stresses generated by the change will not cause damage to the system, this can be done by the use of an expansion loop, an expansion joint or using flexible arms.

#### 1. Expansion loops

These are designed to compensate for linear expansion or contraction within a pipe system. They are an ideal option when facing a large amount of movement, due to expansion or contraction. For large amounts of movement we suggest you use the 100cm flexible connector; solvent weld one end to the pipe where you wish the expansion to be taken up and form a loop before solvent welding the other end to the pipe system.

# Air Sampling Detection

## 2. Expansion joints

In line expansion sockets are a compact solution to allow for 70mm of travel. They have a fixed bracket which is clamped down securely and enables it to be screwed onto M8 or M10 threaded bar. The pipe is pushed into the expansion socket at both ends and must pass the o-ring on each end of the expansion joint.

For contraction requirements the pipes can meet in the middle, and for expansion purposes the pipe from each side has to pass the o-ring sufficiently as to not pull out, whilst the space between the pipes inside the expansion socket will allow for the linear expansion of the pipes up to 70mm.

## 3. Flexible arms

Flexible arms are simple and relatively inexpensive to install. The flexibility of plastics permits expansion or contraction to be compensated for by means of either directional change within a pipe system, or by the installation of expansion loops consisting of two flexible arms. The length of the flexible arm is governed by the pipe diameter, and the amount of expansion or contraction that requires compensation.

## Clips and bracketing

Pipe brackets need to be made with the inside diameter of the bracket marginally larger than that of the pipe outer diameter. This allows for free lineal movement of the pipe, and avoids inhibiting expansion or contraction. They should also be smooth, to avoid damage to the outer surface of the pipe.

Plastic pipe clips meet all these requirements, and are strong, durable against temperature, Ultra Violet (UV) light and can also be used in corrosive or otherwise adverse environmental conditions.

Pipe clips are adaptable and can fixed in the normal way or be screwed onto a M6 or M8 threaded bar by inserting the respective nut into the side of the clip. They can also be fitted to the side of an M6 or M8 threaded bar by utilising a rod adaptor.

## BRACKET SPACING INTERVALS

Plastic pipe lines require regular support, and the spacing of clips or brackets depends on the pipe used and the temperature.

The following tables show the centre-to-centre measurement between brackets for 25mm ABS pipe at various temperatures.

## Specialist accessories

There are a number of important EN 54-20 approved accessories that can be incorporated into the final project design to aid operation and maintenance.

**BLOW THROUGH VALVES** – A blow through system is used to clean the pipe system and/or the air sampling points in restricted areas. The deposits which form in the pipe system in very dusty applications are blown through by means of overpressure applied via non-return end caps installed at the ends of sampling branches. Either a manual or automatic system can be deployed, depending how often the pipe system has to be blown through.

**FILTERS** – These can be installed in the pipework to remove dust particles from the aspirated air in order to extend the life of the system and help prevent false alarms.

**FLAME ARRESTERS** – These in-line devices can be used to create an explosion-proof ASD system for use in hazardous areas.

Bracket Spacing in Metres					
20 °C	30 °C	40 °C	50 °C	60 °C	70 °C
1.00	0.95	0.85	0.75	0.75	0.60

## Gas detection

### VESDA SENSEPOINT XCL MICRO BORE

VESDA Sensepoint XCL can be added to existing or new VESDA-E VEA installations to actively monitor the presence of gases.

It integrates with other building systems, including Fire Alarm Control Panels, PLCs, HVAC and building management systems, and provides real-time situational awareness for intelligent emergency response.

VESDA Sensepoint XCL is capable of remote sampling up to 100m (328ft) providing significant installation and routine maintenance cost savings with easy access to the detector unit for diagnostic information and servicing. Sensor cartridges are easily replaced in the field through simple steps.

### VESDA SENSEPOINT XCL LARGE BORE

VESDA Sensepoint XCL Large Bore is designed to be easily incorporated to existing or new ASD pipe networks without major construction or electrical cabling / conduit and utilises the flow in the pipe for the continuous delivery of air samples to the gas sensor for analysis.

It is capable of remote sampling which means the detector can be placed outside the detection zone at a convenient location for maintenance & service where free business operation, restricted access and safety of personnel is important. Air drawn to the detector can be conditioned to remove contaminants which ensures the detector maintains reliable long-term performance in a wide range of environments.

A single VESDA Sensepoint XCL Large Bore detector delivers multi-point gas sampling capability giving it the advantage of providing larger coverage, increased design flexibility and reliable detection in high airflow areas compared to fixed point gas detectors.

### FAAST FLEX™

FAAST FLEX offers a highly flexible and cost-effective ASD solution for a wide range of applications such as small to medium warehouses, cold storage, elevator shafts, ceiling and underfloor voids, transformer and electrical rooms, rest rooms and the like.

FAAST FLEX offers a highly flexible and cost-effective ASD solution for a wide range of

applications such as small to medium warehouses, cold storage, elevator shafts, ceiling and underfloor voids, transformer and electrical rooms, rest rooms and the like.

## FEATURES AND BENEFITS

- › Reliable smoke detection for consistent performance and minimum nuisance alarms
- › Pipe length up to 270m (886 ft) for single channel and 420m (1378 ft) for dual channel allowing extended coverage and convenient detector mounting
- › An ultrasonic flow sensing element per chamber for accurate and reliable flow detection
- › Simplified and intuitive LED user interface for immediate status indication
- › Pre-engineered pipe networks for hassle-free and expedient design and installation
- › Modular design with in-field replaceable chamber, filter and aspirator for ease of service and maintenance
- › Installation template, different mounting orientations (upright, inverted) and ample wiring room to save time and effort
- › Quiet operation (30db) with adjustable fan speed to suit various environments
- › Suitable for cold storage environments with -40 °C (-40°F) operating temperature
- › Bluetooth interface with mobile device App for extended configuration options and rapid diagnostics
- › General Purpose Input (GPI) for remote Reset, Disable, External Fault
- › Password protected access for secured detector operation, diagnostics and maintenance
- › IP40 rating for protection against ingress of foreign bodies
- › On-board event log up to 2,100 events for user actions and smoke trends

## VESDA

---

VESDA very early warning smoke detection solutions provide the earliest possible warning of an impending fire hazard.

VESDA buys time to investigate an alarm and initiate an appropriate response to prevent injury, property damage or business disruption. As VESDA has the industry's widest sensitivity range (EN54-20 Class A, B & C) and multi-level alarms, even minute levels of smoke can be detected before a fire has time to escalate.

As the world's leading ASD brand specified by fire professionals around the world, VESDA is synonymous with reliable, high-performance fire detection.

### HOW DOES VESDA WORK?













VESDA works by continuously drawing air into a distributed pipe network via a high-efficiency aspirator. The air sample then passes through a dual-stage filter. The first stage removes dust and dirt from the air sample before it enters the laser detection chamber. The second, ultra-fine stage provides an additional clean-air supply to keep the detector's optical surfaces free from contamination, ensuring consistent absolute detection and long detector life as well as minimising nuisance alarms.





From the filter, the air sample goes through the detection chamber where it is exposed to a laser light source. When smoke is present, light is scattered within the detection chamber and is instantly identified by the highly sensitive detection system. The signal is then processed and presented via a bar-graph display, alarm threshold indicators and/or graphic display.

VESDA detectors are able to communicate this information to a fire alarm control panel, a software management system, or a building management system via relays or connection to Ethernet.

There are numerous VESDA detectors to suit applications depending on size of area and the customers desire for visual information. There are also units offering point addressability and detectors specifically designed for harsh applications.

## Product Range at a Glance

	Part Number
	VESDA VEU with LEDs VEU-A00
	VESDA VEU with 3.5" Display VEU-A10
	VESDA 4 Pipe VEP with LED's - Black Plastic VEP-A00-P
	VESDA 4 Pipe VEP with 3.5" Touchscreen Display - Black Plastic VEP-A10-P
	VESDA Single Pipe VEP with LED's - Black Plastic VEP-A00-1P
	VESDA-E VES SCANNER DETECTOR WITH LED's VEP-A00-P
	VESDA-E VES DETECTOR WITH 3.5" DISPLAY VES-A10-P
	VESDA-E VEA-40 DET with LEDs VEA-040-A00
	VESDA-E VEA-40 DET with 3.5" Display VEA-040-A10
	VESDA Small Area Detector VLF-250-00
	VESDA Smallish Area Detector VLF-500-00
	VESDA VLI with VESDAnet VLI-885

	Part Number
	VESDA VLI with relays and Ethernet only VLI-880
	VESDA Sensepoint XCL - Micro Bore Various
	VESDA Sensepoint XCL - Large Bore Various
	FAAST FLEX 1-Pipe Stand-alone FLX-010
	FAAST FLEX 2-Pipe Stand-alone FLX-020



# Flame Detection

Flame detection is a specialist detection technique that can be deployed in areas where there is a specific risk that will result in immediate flame in the event of ignition as opposed to smoke detection that we cover in this document. Additionally, flame detection will be deployed in areas that have been designed as ATEX hazardous areas where products installed within that area cannot add to the risk of causing ignition of the presence of gas.









Typical applications where flame detection is deployed are:

- › Refineries and oil production facilities
- › Off-Shore platforms
- › Turbine/compressor enclosures
- › Oil and gas pipelines and pumping stations
- › LNG/LPG loading and unloading facilities
- › Natural gas and CNG plants
- › Aircraft hangars
- › Conveyor belts
- › Indoor chemical, fuel and solvent storage
- › Recycling and waste processing plants

The Notifier range of flame detection is available with a number of flexible detection techniques and with devices that will cover both Zone 1 and Zone 2 ATEX areas.





# Flame Detection

## Zone 1 ATEX Rated Devices

	Part Number
	Flame IR3 60m Zone 1 Red Aluminium FS24X-911-23-6
	Flame IR3 60m Zone 1 Stainless Steel FS24X-911-24-6
	Flame IR2/UV 60m Zone 1 Red Aluminium FS20X-211-23-6
	Flame IR2/UV 60m Zone 1 Stainless Steel FS20X-211-24-6
	Flame FS20X/24X Test lamp Hazardous Area TL-2055
	Flame FS20X/24X Test lamp Safe Area TL-1055
	Flame FS20X/24X Swivel Mount SS. SM4
	Flame FSX Diagnostic Kit c/w Interface Module, RS485/USB Cable, PSU, Win PC Software FSX-A001
	Flame IR Bulb for TL Test Lamps FSX-A006
	Flame Charger kit for TL test lamp PSU-12
	Flame Electronics Module for FS24X detector FS24X-911-10-6
	Flame Electronics Module for FS20X Detector FS20X-211-10-6

	Part Number
	Flame FS20X/24X Dust Airshield with fitting for 6mm hose DASA6-N
	Flame FS20X/24X Sunshield SH-001

## Zone 2 ATEX Rated Devices

	Part Number
	Flame UV 25m Zone 2/22 Red FSL100-UV
	Flame UV/IR 25m Zone 2/22 Red FSL100-UVIR
	Flame IR3 35m Zone 2/22 Red FSL100-IR3
	Flame FSL100 Swivel Mount FSL100-SM21
	Flame FSL100 Test Lamp FSL100-TL
	Flame 12V DC Battery for FSL test lamp FSL100-TLBT
	Flame H3 Bulb for FSL test lamp FSL100-TLBU
	Flame Charger kit for FSL test lamp FSL100-TLCH



# Wireless Fire Detection

The Agile™ Wireless Fire Detection system offers unmatched levels of communication reliability and installation flexibility. It provides a robust and efficient method of delivering an integrated smoke detection solution across a wider variety of applications, with greater simplicity and scalability.

The platform is built on a powerful mesh technology, with multiple communication paths to minimise interference and maximise system robustness.

# Agile™ Wireless Fire Detection

## Key applications historic and hard-to-wire buildings

The Agile™ wireless platform is ideally suited to heritage sites, museums or complex applications with aesthetic challenges or otherwise limiting restrictions such as asbestos, concrete walls and ceilings or inaccessible wiring.

## Refurbishments and retrofits

Since the Agile™ platform can be used effectively as a wired system extension, it is well suited to refurbished buildings or retrofits where it is uneconomical or impractical to have a wired installation. Agile IQ™ wireless software tools allow rapid installation without business disruption.

## Temporary fire protection and time pressured projects

The flexibility and speed of installation of the Agile™ wireless fire detection solution makes it the first choice technology for applications where temporary fire protection is needed, such as construction sites, exhibition booths and portable classrooms. It is also ideal for time-pressured projects with short deadlines.

## What is Agile™?

- › A new wireless fire detection system based on mesh technology for maximum reliability
- › A range of devices with the same look and feel as our wired devices, to provide a consistent appearance and make installation and maintenance simple
- › A 3-in-1 software suite called Agile IQ™ for easy design, configuration and diagnostics
- › A range of accessories, tools and hardware needed for installation and maintenance



## Agile™ uses cutting edge technology mesh network communication reliability

Mesh technology is now well-established and growing in many different sectors and has overtaken the 'Star' or 'Hub and Spokes' network topology due to its 'self-healing' ability.

Whereas nodes in Star networks have a single and fixed path to the network Gateway, the nodes in Mesh networks are each able to function as a network router that allows multiple paths back to the Gateway should one link be lost.

To further enhance system reliability and scalability, and improve overall system robustness Agile™ features:

- › 18 communication channels to reduce probability of interference
- › The ability to switch between channels in the case of interference (Channel Diversity)
- › Two antennae per device to reduce the impact of device positioning errors (Antenna Diversity)
- › Extended communication range to provide a margin against interference

## Five key reasons to choose Agile™ mesh technology



1

**Mesh network multiple communication paths guarantees uninterrupted communications**



2

**Wireless monitoring visual network representation for easier troubleshooting**



3

**Installation flexibility enables easy installation of system extensions or temporary systems**



4

**Smart battery monitoring accurate service life prediction**



5

**Communication range provides more margin against interference**

# Agile™ Wireless Fire Detection

## Star network

In a star network, wireless devices are in direct communication with either a central wireless gateway or a repeater. Temporary obstacles such as metal filing cabinets or new internal walls can affect the system integrity, causing a break in

communication. This renders the system partially inactive, resulting in the area no longer being protected. This can be avoided using a mesh network.

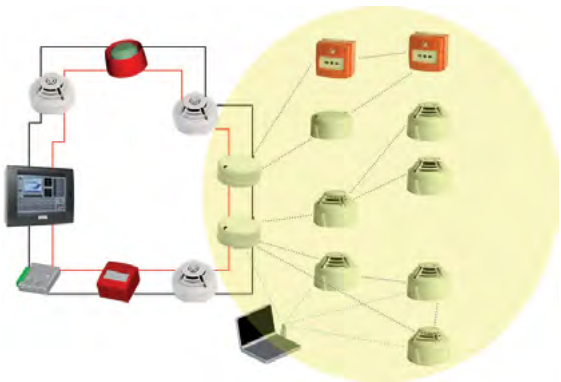
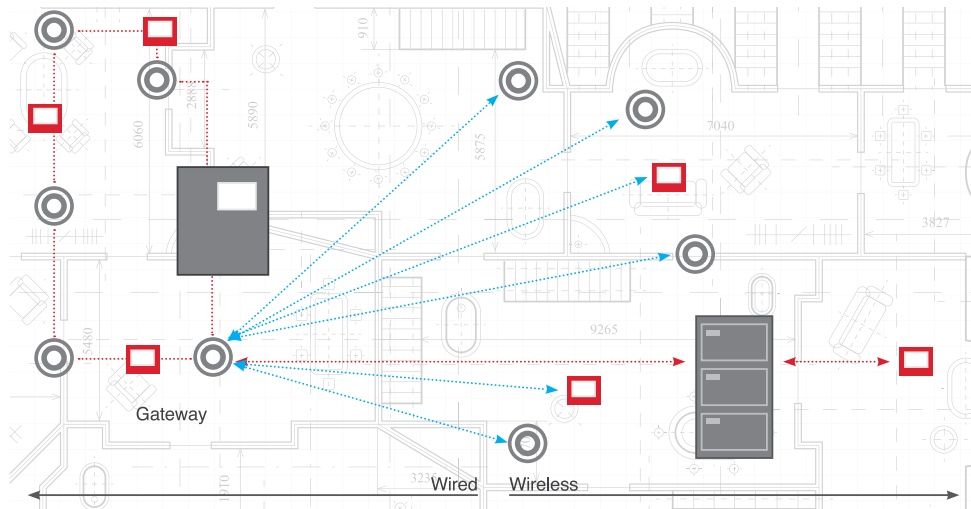

Hard and wireless systems integration

## Agile™ mesh network

In a mesh network, each device acts as an independent router, allowing for multiple communication paths. The Agile™ solution is designed so that if one link is broken, all of the devices continue to communicate with each other without any loss of coverage.

The EN 54-25 standard for wireless fire detection requires that communication paths are not susceptible to interference from either inherent or external sources. The Agile multichannel frequency diversity ensures that this requirement is met, providing maximum levels of fire protection.

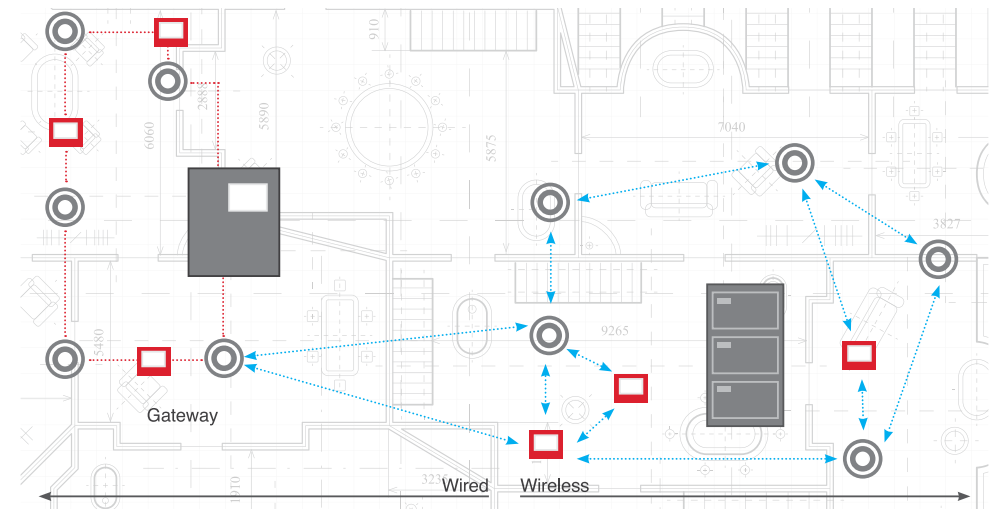

# Agile™ Wireless Fire Detection

## 3-in-1 Agile IQ™ software

The new Agile™ Wireless Fire Detection system offers unmatched levels of communication reliability and installation flexibility. It provides a robust and efficient method of delivering an integrated smoke detection solution across a wider variety of applications, with greater simplicity and scalability.

The platform is built on a powerful mesh technology, with multiple communication paths to minimise interference and maximise system robustness.

### 1. DESIGN

The Agile IQ™ design software tool allows the user to design and simulate the quality of the wireless network from their office, without the need to be on site. Building maps can be easily imported via the software as images or CAD files. Networks can be easily tested to identify critical communication links, which should be tested during a site survey.

### 2. CONFIGURATION

The Agile IQ™ configuration software tool allows the device configuration to be performed either before or after the devices are installed in their final position. This provides the installer with a greater degree of flexibility and can reduce commissioning time.

### Panel integration

Agile™ wireless devices appear the same on the panel as their wired equivalents and can be integrated with the overall fire system – allowing for easy network interrogation via the panel or through the Agile IQ™ software.

### Device compatibility

The installer's job is further simplified as devices have the same look and feel as their wired equivalents and addresses are set using the familiar rotary switches. The gateway – the main communication interface between the panel and the wireless device – plugs into a standard detector base, allowing for easy and effective system extensions.

### 3. DIAGNOSTICS

The Agile IQ™ diagnostic software tool provides a real time picture of the network status without compromising the operation of the system.

The combination of the software and Agile™ USB dongle allows the user to effectively track performance and pinpoint any faults on site. With a few clicks a report containing the survey results can be generated. Troubleshooting is more accurate and problems are easier to resolve.

## Smart battery service prediction

Patented monitoring technology provides accurate battery service life prediction, reducing unplanned maintenance requirements. This eliminates the need to replace batteries on every inspection and allows proactive planning of battery replacement.









## Feature summary and benefits

- › Wireless mesh network bi-directional communication technology – ensures full integration with existing systems
- › Two communication paths to each wireless device – creates a more robust and reliable system
- › 18RF channels at 868MHz – provides greater tolerance to interference
- › Two integrated antennae on each wireless fire device – easier positioning of devices
- › Up to 400m free-air communication range – providing good coverage levels
- › Average five-year battery service life – reducing maintenance requirements
- › Addresses set using rotary switches – reduced commissioning time
- › Wired fire devices look and feel – easier installation and visual integration
- › Patented battery service life prediction feature – more proactive maintenance
- › Loop powered gateway – reduced installation cost and time
- › Up to eight gateways per loop
- › Up to 32 wireless devices per gateway
- › Agile IQ™ 3-in-1 software for easy design, configuration and diagnostics

# Agile™ Wireless Fire Detection

## Product range at a glance

	Part Number
 Photo Detector. Wireless optical smoke detector for the Notifier Agile wireless system. Powered by 4 x CR123A 3v batteries	NRX-OPT
 Photo-Thermal-IR Detector. Wireless Smart 3 (Optical, Thermal and Infrared) detector for the Notifier Agile wireless system. Powered by 4 x CR123A 3v batteries	NRX-SMT3
 Rate of Rise Heat Detector. Wireless 'Rate of Rise' heat detector for the Notifier Agile wireless system. Powered by 4 x CR123A 3v batteries	NRX-TDIFF
 58°C Fixed Temperature Heat Detector. Wireless fixed temperature (58°C) heat detector for the Notifier Agile wireless system. Powered by 4 x CR123A 3v batteries	NRX-TFIX58
 Detector/Repeater Base. Base for Notifier Agile wireless detectors and repeater.	B501RF
 Remote Indicator for Agile Wireless. Wireless LED indicator for Notifier Agile wireless systems. Indicates the status of up to four Notifier Agile wireless detectors via three coloured LEDs.	NRX-IRK
 WCP call point. Waterproof Manual Call Point for the Notifier Agile wireless system. With magnetic anti-tamper mechanism and IP67-rating.	NRX-WCP
 Agile Wireless I/O module for the Notifier Agile wireless system. Powered by 4 x CR123A 3v batteries.	NRX-M711
 Gateway. Loop-powered Gateway device for Notifier Agile wireless system. Up to 8 Gateways may be used on the same loop. Compatible with B501AP base.	NRXI-GATE
 Repeater. Network Repeater for extending the range of Notifier Agile wireless networks. Powered by 4 x CR123A 3v batteries.	NRX-REP

	Part Number
 USB Dongle. USB dongle for managing Notifier Agile wireless systems together with Agile IQ software on a PC.	NRX-USB
 CUP. Cup for setup and maintenance of Notifier Agile wireless detectors. For use with telescopic pole (POLE HWKIT)	CUP HWKIT
 Adapter for No Climb Solo poles – for use with CUP HWKIT	SOLOADAPT HWKIT
 Wireless Sounder - Red	NRX-WS-RR
 Wireless Sounder - White	NRX-WS-WW
 Base Plate for Wireless Sounder - Red	B501RF-RR
 Base Plate for Wireless Sounder - White	B501RF
 Wall mounted addressable wireless sounder VAD - Red/Red	NRX-WSF-RR
 Wall mounted addressable wireless sounder VAD - White/Red	NRX-WSF-WR



# Audible and Visual Alarm Devices

Sounders and strobes are generally provided for systems designed to protect life. However, on the rare occasion when only the property is being protected it is still essential to mount a sounder adjacent to the fire control panel as well as immediately outside the main entrance for the Firefighters.

Before deciding on the number and location of sounder/ visual alarms, it is important to establish what the 'Fire Plan' or Cause & Effect will be based on the risk assessment.

If the building is not going to have a 'one out-all out' arrangement, the evacuation procedures must be established. Once this is known, you can then establish the alarm zone areas where different alarm messages may be given.

## Legislation and Codes of Practice

- › EN5 4 Part 3 & EN 54 Part 23
- › BS 5839-1:2017 – Design, Installation, Commissioning and Maintenance fire detection and alarm systems
- › LPCB Code of Practice CoP0001

# Audible and Visual Alarms

## Audible alarm signals

### SOUNDER VOLUME

The general requirement for the volume of audible alarm signals is that they should provide a Sound Pressure Level (SPL) of at least 65dB(A), but not more than 120dB(A) throughout all accessible areas of a building.

Exceptions to this general rule are as follows:

- › In stairways the SPL may be reduced to 60dB(A)
- › Enclosures less than 60m<sup>2</sup> may be reduced to 60dB(A)
- › There is no minimum for enclosed areas less than 1m<sup>2</sup>
- › At specific points of limited extent the SPL may be reduced to 60dB(A)

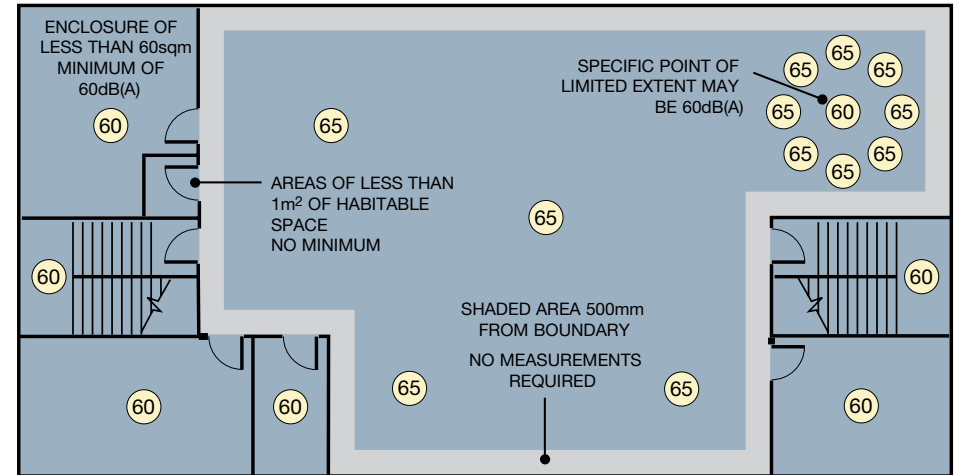
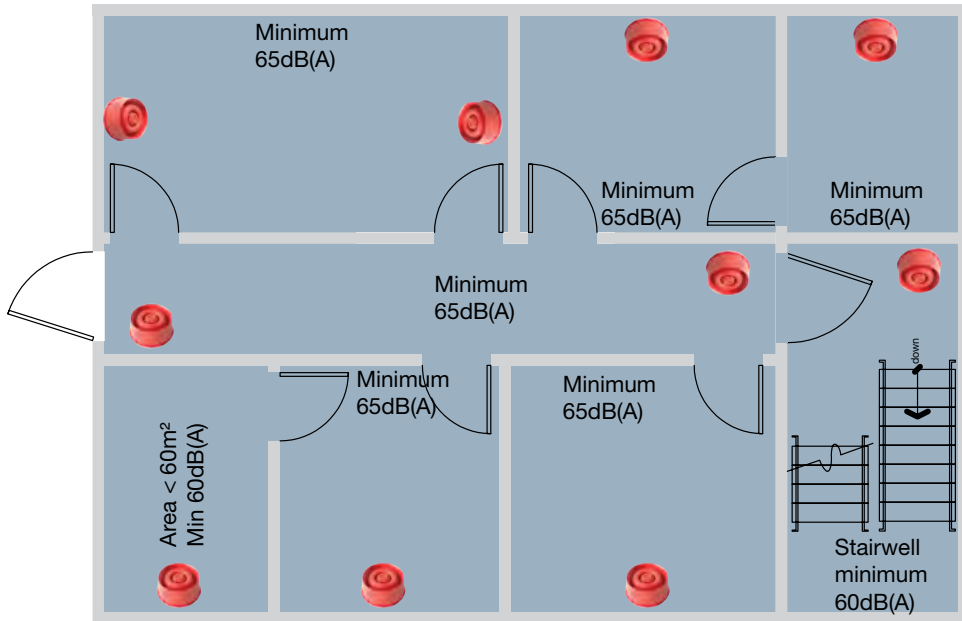

Where a continuous background noise level greater than 60dB(A) is present the fire alarm signal should be 5dB above the ambient, but not greater than 120dB(A).

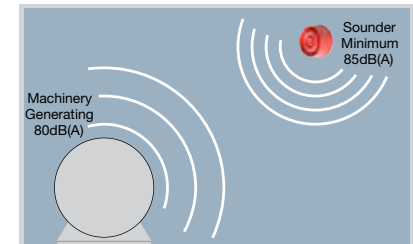

Where the alarm is intended to wake people, an SPL of 75dB(A) is required at the bed head. Generally this will require a sounder to be placed within the room.

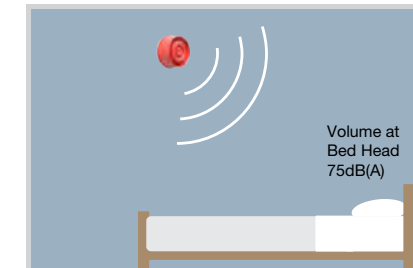

Where it is not possible to place a sounder within a room, there will be a loss of approximately 20dB(A) through a standard door, and 30dB(A) through a fire door.

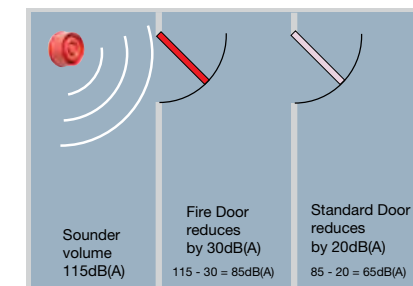

**WARNING: Volumes greater than 120dB(A) will cause damage to hearing.**

# Audible and Visual Alarms

In open space, as the distance from a sounder doubles, the sound level will be reduced by 6dB(A), as shown.

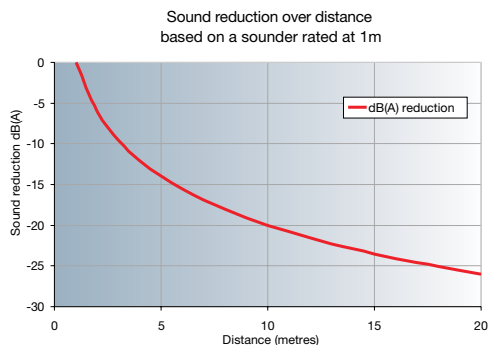

It is preferable to use multiple quieter sounders to achieve the required sound level, rather than a smaller number of loud devices. This is to prevent points of excessive volume, which may lead to disorientation or damage to hearing.

Two sounders providing equal sound levels will combine to add 3dB(A) to the SPL.

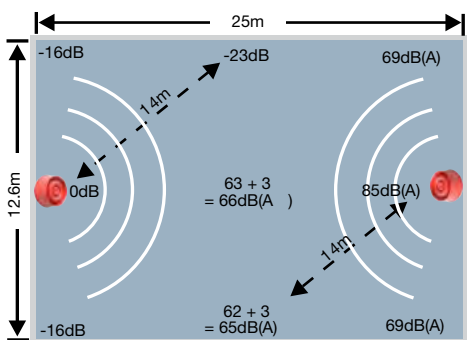

It is essential that at least one sounder is placed within each fire compartment and the sounder choice should be common throughout the building. You should not mix bells and electronic sounders within the same building.

## Visual alarm devices

In the event of a fire alarm being activated Visual Alarm Devices (VADs) complying to EN 54-23 are only required if they are considered to be the primary source of evacuation to building occupants as defined within the building's fire risk assessment.

If sounders are considered as the primary source of evacuation these should comply to EN 54-3 and light may be used to provide supplementary indication. However, in line with best practice, Notifier recommends that both the audible and visual elements of an alarm device should comply with the relevant EN 54 standards.

## Regulations for visual alarm devices

### EN 54 PART 23:2010

EN 54 is a collection of product standards that controls the design and manufacture of the components of a fire detection and alarm system.

EN 54-23 is the section that refers to VADs. It provides a means of ensuring VADs from any manufacturer meet consistent minimum standards of performance ensuring systems are designed, installed and perform as intended.

All beacons used as a primary method of notification must have the capability to alert all members of society to an evacuation including the hearing impaired.

## CPR - construction products regulation

EU regulation that ensures building products are safe and are compatible with other systems in the building. CPR was introduced in the UK and Ireland in July 2013. EN 54-23 was granted a delay until December 2013. This requires that VADs are certified to EN 54-23 and covered by a declaration of performance (DoP) issued by the manufacturer.

## BS 5839-1:2017

Code of Practice for design and installation of fire detection and alarm systems. This recommends that Visual Alarm Devices should comply with EN 54-23.

## LPCB Code of Practice CoP0001

Where a strobe or beacon is considered to be the primary source of evacuation as defined in the fire risk assessment, it is important to choose a product capable of delivering the required light output. The LPCB Code of Practice (CoP001) provides design guidance for visual alarm devices used for fire warning. Some of the elements that need to be considered to deliver a compliant solution are detailed as follows:

- › Level of ambient light
- › Required field of view (direct or indirect viewing)
- › Reflectivity of surfaces
- › Effect of colour
- › Tinted Eye Protection (white would be more effective)
- › Usage and occupation
- › Environmental conditions

# Audible and Visual Alarms

## Applications

The method of signalling alarms is always defined by the Fire Risk Assessment. Bells, electronic sounders and more recently voice alarm are widely accepted means of alerting a building's occupants.

Audible alarms are not always suitable and a visual alarm can be used as an alternative. BS EN 5839-1:2017 lists examples of when VADs might be considered.

- › Areas of high background noise where people might be wearing ear defenders e.g. factories or warehouses
- › Areas where people might not hear an audible alarm e.g. gymnasiums, call centres/telesales
- › Areas with managed evacuation e.g. cinemas
- › Areas where critical processes may have to continue even in a fire emergency, e.g. hospital operating theatres or TV studios
- › Perhaps the most common reason for choosing to use VADs as alarm devices is to indicate the emergency to the deaf and hard of hearing particularly since the introduction of legislation (Equality Act 2010) made it a requirement to consider all occupants

For comprehensive guidance on designing systems using VADs please refer to CoP0001, a publication jointly prepared by the LPCB and the Fire Industry Association (FIA).



Part 23 O class sounder beacon

The basic requirement when using VADs as a primary means of alert is for a VAD to provide a minimum luminance of 0.4 lux throughout a given volume of room space to attract the attention of people in a room.

To achieve this objective, EN 54-23 defines three categories of VAD defining the mounting position and performance of the device – C,W and O.

### CATEGORY C – CEILING MOUNTED

Ceiling mounted VADs are suited to large open areas where wall mounted devices might not cover the whole room space.



A ceiling category VAD is required to provide an luminance of at least 0.4 lux in a cylinder. The coverage volume is defined in the performance category 'C-X-Y' where:

C-X-Y	X – Cylinder Height	Y – Cylinder Diameter
C-3-10	3m	10m

### CATEGORY W – WALL MOUNTED

A wall mounted VAD provides minimum luminance of 0.4 lux in a cube. The coverage is defined by the category in the form of 'W-X-Y' where:

W-X-Y	X – Mounting Height	Y – Dimension of a Square
W-2.4-6	2.4m - 11.5m	11.5m x 11.5m



### CATEGORY O – OPEN CATEGORY

The coverage of a Category O device is defined by the manufacturer who must state the height/ placement requirements to allow the designer to achieve the minimum light levels.

### DEFINED LIGHT COVERAGE FOR CEILING MOUNT (CATEGORY C) APPLICATIONS

The diameter of a cylinder of light with a minimum of 0.4 Lumens/m<sup>2</sup>

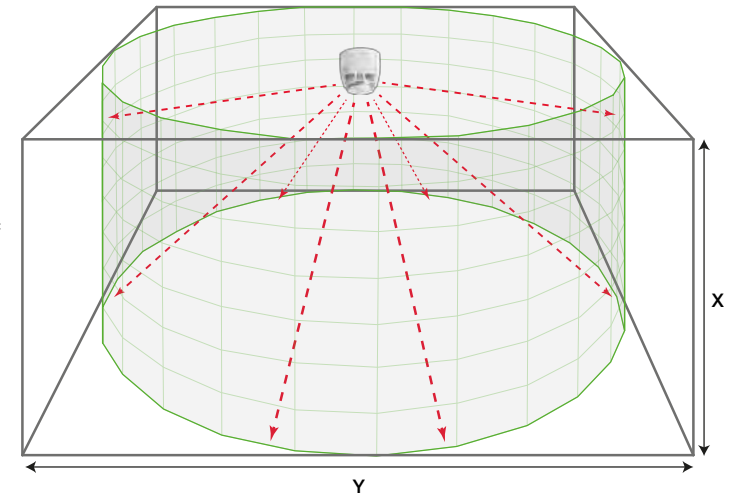

### DEFINED LIGHT COVERAGE FOR WALL MOUNT (CATEGORY W) APPLICATIONS

A cube of light with a minimum of 0.4 Lumens/m<sup>2</sup>

X & Y dimensions are defined by the device manufacturer

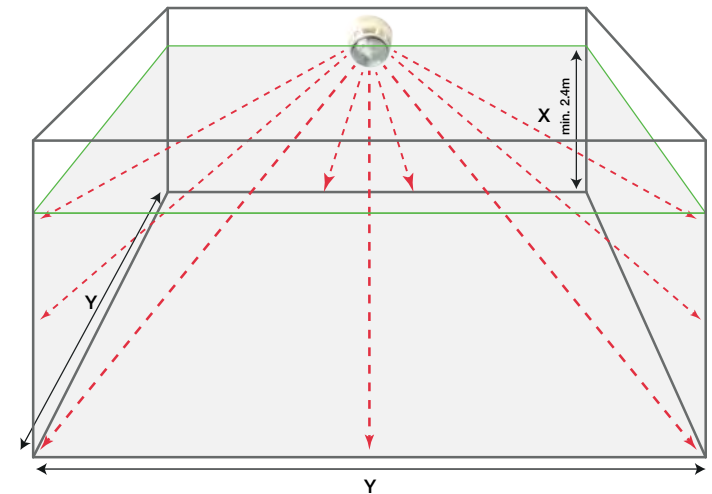

### OPEN CATEGORY (CATEGORY O) APPLICATIONS

The coverage of a Category O device is defined by the manufacturer who must state the height/ placement requirements to allow the designer to achieve the minimum light levels.





# Audible and Visual Alarms

## Product range at a glance

### INTELLIGENT ADDRESSABLE DEVICES

	<b>Base Sounder</b> Addressable loop powered base sounder, EN 54-3 approved. WHITE. Built in loop isolation.	BSO-PP-I02
	<b>Base VID</b> Addressable loop powered visual indicating device (VID). White body, clear lens with red flash. Built in loop isolation. This product is not approved to EN54-23 (Visual Alarm Device) and must not be used as a visual alarm device to provide a primary warning notification of fire.	BST-PC-I02
	<b>Base Sounder VAD</b> Red Flash, Pure White Body, Clear Lens c/w Isolator. Loop-powered EN54-23 Open Category Detector Base Sounder Strobe.	DSS-PC-102
	Standard EN54-23 C-Category Base Sounder Strobe	BRS-PC-I02
	Premium EN54-23 C-Category Base Sounder Strobe	BRH-PC-I02
	Standard EN54-23 C-Category Base Strobe	BGL-PC-I02
	Base Sounder - Addressable loop powered base sounder, EN54-3 approved. WHITE. Built in loop isolation.	BSO-PP-I02
	Base Sounder - Addressable loop powered base sounder, EN54-3 approved. BLACK Painted. Built in loop isolation.	BSO-BB-I02
	<b>Wall Sounder</b> Addressable wall mounted loop powered sounder, EN 54-3 approved. Red. Built in loop isolation.	WSO-PR-I02
	<b>Wall Sounder</b> Wall mounted, addressable, loop powered sounder, EN 54-3 approved, WHITE, with built in loop isolation.	WSO-PP-I02
	<b>Wall Sounder VID</b> Wall mounted, addressable, loop powered sounder, EN 54-3 approved, with visual indicating device (VID), Red lens. Built in loop isolation. This product is not approved to EN 54-23 (Visual Alarm Device) and must not be used as a visual alarm device to provide a primary warning notification of fire.	WSS-PR-I02
	<b>Wall Sounder VAD</b> Wall mounted, addressable, loop powered sounder, EN 54-3 approved, with Visual Alarm Device (VAD), EN 54-23 O Class compliant. Clear lens with red flash. Built in loop isolation.	WSS-PC-I02
	<b>Wall VAD</b> Wall mounted, addressable loop powered EN 54-23 O Class compliant clear lens with red flash. Built in loop isolation.	WST-PC-I02
	<b>Wall / Ceiling VAD</b> White flash EN 54-23 W-2.4-2.7 and C-3-5.1 / C-6-5.1 / C-9-5.1 class approved strobe with clear lens and White body, provides omni directional wall and ceiling mounting to ensure correct installation first time. Built in loop isolation. This part is now obsolete and has been replaced by the part numbers to the right.	BGL-PC-I02 + IBS-LIDPW (C-Class) or WWL-PC-I02 (W-Class)









### INTELLIGENT ADDRESSABLE DEVICES

	<b>Base</b> Addressable base for detector and AV – concealed when AV unit installed, use for all colours.	B501AP
	Analogue sensor base with SEMS screw connections for isolated and non-isolated detectors and address identification label. BLACK.	B501AP-BK
	<b>Deep Base</b> Addressable deep base for detector and AV, Red (including B501AP base).	BRR
	<b>Deep Base</b> Addressable deep base for detector and AV, WHITE (including B501AP base).	BPW
	<b>Deep Sealed Base</b> Addressable sealed deep base for detector and AV, Red (including B501AP base).	WRR

### NON-ADDRESSABLE DEVICES

	<b>Red body with white flash</b> EN 54-Pt.3 and Pt.23 W-2.4-8.9 and C-3-10 / C-6-10 class approved sounder strobe with clear lens, provides omni directional wall and ceiling mounting, suitable for 12 and 24V systems.	CWSS-RW-S5
	<b>Red body with white flash, IP65 deep base</b> EN 54-Pt.3 and Pt.23 W-2.4-8.9 and C-3-10 / C-6-10 class approved sounder strobe with clear lens, provides omni directional wall and ceiling mounting, suitable for 12 and 24V systems.	CWSS-RW-W5
	<b>Red body with red flash</b> EN 54-Pt.3 and Pt.23 W-2.4-6.0 and C-3-8.9 / C-6-8.2 class approved sounder strobe with clear lens, provides omni directional wall and ceiling mounting, suitable for 12 and 24V systems.	CWSS-RR-S5
	<b>Red body with red flash, IP65 deep base</b> EN 54-Pt.3 and Pt.23 W-2.4-6.0 and C-3-8.9 / C-6-8.2 class approved sounder strobe with clear lens, provides omni directional wall and ceiling mounting, comes with softstart feature as standard and suitable for 12 and 24V systems.	CWSS-RR-W5
	<b>White body with white flash</b> EN 54-Pt.3 and Pt.23 W-2.4-8.9 and C-3-10 / C-6-10 class approved sounder strobe with clear lens, provides omni directional wall and ceiling mounting, suitable for 12 and 24V systems.	CWSS-WW-S5
	<b>White flash</b> EN54-23 W-2.4- 9.0 and C-3-9.5 / C-6-9.5 /C-9-9.5 class approved strobe with clear lens and red body, provides omni directional wall and ceiling mounting to ensure correct installation first time, suitable for 12 and 24V systems.	CWST-RW-S5
	<b>White flash, IP65 deep base</b> EN 54-23 W-2.4- 9.0 and C-3-9.5 / C-6-9.5 /C-9-9.5 class approved strobe with clear lens and red body, provides omni directional wall and ceiling mounting to ensure correct installation first time, suitable for 12 and 24V systems.	CWST-RW-W5
	<b>Red flash</b> EN 54-23 W-2.4- 6.2 and C-3-9.4 / C-6-8.6 class approved strobe with clear lens and red body, provides omni directional wall and ceiling mounting to ensure correct installation first time, suitable for 12 and 24V systems.	CWST-RR-S5
	<b>Red flash, IP65 deep base</b> EN 54-23 W-2.4- 6.2 and C-3-9.4 / C-6-8.6 class approved strobe with clear lens and red body, provides omni directional wall and ceiling mounting to ensure correct installation first time, suitable for 12 and 24V systems.	CWST-RR-W5
	<b>Red</b> EN 54-3 approved low profile wall and ceiling mount sounder, 32 tones including new bell tone, suitable for 12 and 24V systems.	CWSO-RR-S1
	<b>Red</b> EN 54-3 approved IP65 deep base wall and ceiling mount sounder, 32 tones including new bell tone, suitable for 12 and 24V systems.	CWSO-RR-W1

NON-ADDRESSABLE DEVICES

	<b>White</b> EN54-3 approved low profile wall and ceiling mount sounder, 32 tones including new bell tone, suitable for 12 and 24V systems.	CWSO-WW-S1
	<b>Wall Sounder VAD</b> Wall Mount Sounder Strobe EN54-23 W-CAT RED FLASH WHITE BODY Notifier	WRA-PC-I02
	<b>Wall Sounder VAD</b> Wall Mount Sounder Strobe EN54-23 W-CAT RED FLASH RED BODY Notifier	WRA-RC-I02
	<b>Wall Sounder VAD</b> Wall Mount Sounder Strobe EN54-23 W-CAT WHITE FLASH WHITE BODY Notifier	WWA-PC-I02
	<b>Wall Sounder VAD</b> Wall Mount Sounder Strobe EN54-23 W-CAT WHITE FLASH RED BODY Notifier	WWA-RC-I02
	<b>Wall VAD</b> Wall Mount Strobe Only EN54-23 W-CAT RED FLASH RED BODY Notifier	WRL-RC-I02
	<b>Wall VAD</b> Wall Mount Strobe Only EN54-23 W-CAT RED FLASH WHITE BODY Notifier	WRL-PC-I02
	<b>Wall VAD</b> Wall Mount Strobe Only EN54-23 W-CAT WHITE FLASH WHITE BODY Notifier	WWL-PC-I02
	<b>Wall VAD</b> Wall Mount Strobe Only EN54-23 W-CAT WHITE FLASH RED BODY Notifier	WWL-RC-I02



# VA/PA Voice Alarm and Public Address Systems

This section is aimed at supporting designers on Voice Alarm (VA) and Public Address (PA) systems and their use in conjunction with advanced fire detection systems. Incorporating the requirements of BS 5839-8:2023, it highlights some of the main considerations in system design. This guide is intended as an aid and there is no substitute for reading the full standard.

## Legislation and Codes of Practice

This guide sets out to highlight the key considerations but there is no substitute for a sound knowledge of the standards. BS 5839-8:2023 is the Code of Practice covering the requirements for the design, installation, commissioning and maintenance of Voice Alarm Systems. It sets out in great detail the steps that should be followed to achieve a system meeting the needs of the application.

Other standards are also relevant and should be consulted:

- BS EN 54-3
- BS EN 54-4
- BS EN 54-16
- BS EN 54-23
- BS EN 54-24
- BS 5839-1:2017 - Fire detection and fire alarm systems for buildings Part 1 - Code of Practice for design, installation, commissioning and maintenance of systems in non-domestic premises
- BS 7827:2019 - Designing, specifying, maintaining and operating emergency sound systems for sports grounds, large public buildings and venues
- BS EN 50849:2017 - Sound systems for emergency purposes
- BS 9999:2017 - Fire safety in the design, management and use of buildings

# Voice Alarm and Public Address

## VA system design checklist

To achieve the right VA design, a number of simple steps need to be followed. This guide leads you through the steps in a sequence that will deliver a good design.

- › Regulations for Voice Alarm
- › Why do we need Voice Alarm?
- › Voice Alarm System Selection
  - › Management of Evacuation
  - › Voice Alarm System Types
- › Customer Requirements
  - › Voice Alarm and Public Address
  - › Microphones and other inputs
  - › Background Music and Entertainment
  - › Messages
- › System Architectures
- › Loudspeaker Design

## Why do we need Voice Alarm?

There is some well documented research<sup>1,2</sup> into the human behaviour in the event of fire.

Most striking is the variation in the response to alarm signals:

- › 13% of people react in a timely manner to bells
- › 45% of people react to text information
- › 75% of people react in a timely manner to voice messages

Further research shows that people’s behaviour varies dependent on the environment, and in an emergency they may exit the building using the same door they used to enter. The use of a clear voice message greatly increases response time and provides the opportunity to advise occupants of the safest emergency route.

## Management of evacuation

Before deciding on a Voice Alarm System design the evacuation requirements of the building must be established:

- › Is the building to be evacuated all at once (one-out-all-out)?
- › Does the building require a phased evacuation strategy?
  - › In the example shown below only part of the building is evacuated immediately
  - › Whilst other areas will have an alert or standby message

1: Guylène Proulx, Ph.D, ‘Misconceptions about human behaviour in fire emergencies’ published in Canadian Consulting Engineer, March 1997, pp36, 38.

2: David Cantor, ‘Studies of Human Behaviour in Fire: Empirical results and their implications for education and design.’ Published by BRE, July 1985.

LOUDSPEAKER CIRCUIT	LOCATION	VA ZONE
1	Function Room	1
2	Public Bar	2
3	Bar Cellar	2
4	Public Lounge	3
5	Staff Room	3

Note: For the Voice Alarm System, only three channels are needed to allow separate messages to be broadcast simultaneously.

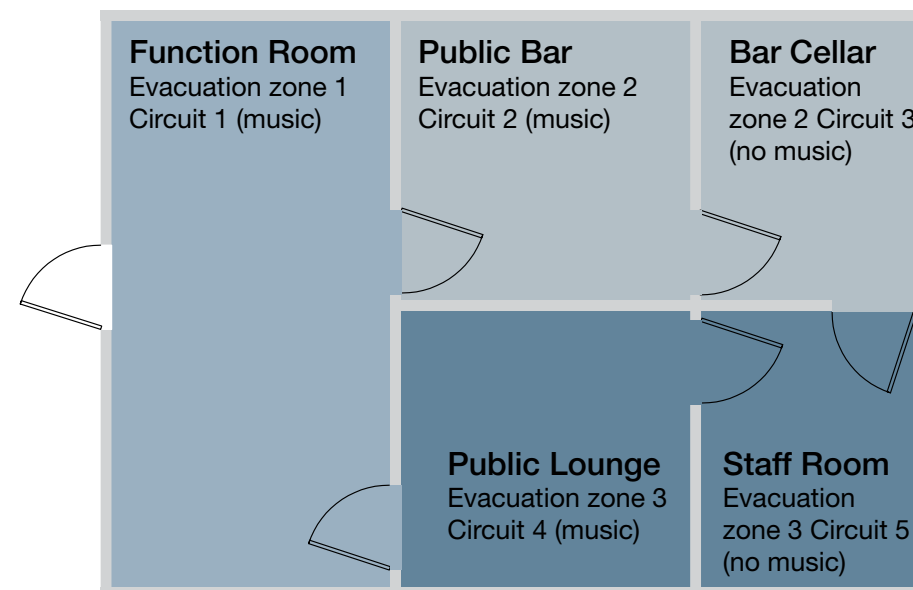

# Voice Alarm and Public Address

## Voice alarm system types

Once the evacuation strategy of the building is understood, the designer should assess the type of voice alarm system that should be used.

The level of manual control and the need for live messages versus automated messages will drive the decision on the type of system installed. BS 5839-8:2023 defines five types of systems and these are summarised below:

### Type V1: Automatic evacuation

This system offers automatic operation of the voice alarm system against a pre-defined evacuation plan. The system may also have non-fire related facilities for the manual operation and initiation of non-fire emergency messages, provided that these are automatically overridden by non-fire related emergency messages.

### Type V2: Live emergency messages

In addition to the automatic facilities provided by the Type V1 system, the Type V2 system provides the facility for automatic message initiation as well as the facility to broadcast live emergency messages by means of an all-call emergency microphone situated at a strategic control point. This allows supplementary live announcements to aid safe evacuation.

### Type V3: Zonal live emergency messages

In addition to the functions of the Type V2, the facility to broadcast live emergency messages in pre-determined emergency zones, or groups of zones. This allows evacuation control in specific areas of the building where a pre-determined evacuation plan might not cover all eventualities.

### Type V4: Manual controls

Type V4 system has the facility to select and direct stored emergency messages to individual zones as well as the ability to disable or enable emergency broadcast messages and display their status. This allows designated, well-trained and disciplined staff to follow a pre-planned evacuation strategy when the automatic mode needs to be overridden.

### Type V5: Engineered systems

Where the application falls outside the scope of type V1-V4, a type V5 system allows the design of a tailored solution based on the assessment of special or mutable risks.

## Customer requirements voice alarm and public address

Is the system to be used only for Voice Alarm or a combination of Voice Alarm, Public Address and maybe even music?

If so, the zoning requirements for Voice Alarm Evacuation may be different non-emergency from Public Address.

In the example shown below, there is a requirement for three separate paging zones and two areas for music, as well as three alarm zones.

Loudspeaker Circuit	Location	VA Zone	PA Zone	Music
1	Function Room	1	1	
2	Public Bar	2		1
3	Bar Cellar	2	2	
4	Public Lounge	3		2
5	Staff Room	3	3	

Note: This results in five separate loudspeaker circuits capable of delivery VA, PA and/or music in the separate compartments simultaneously.

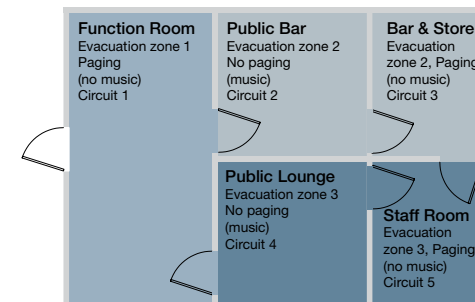

## Microphones and other inputs

How many microphones are needed and what are they used for?

Microphones may be used to broadcast live messages both in an emergency and for general public address.

For emergency use, microphones must be operated and be monitored in accordance with BS 5839-8:2023 and be certified to BS EN 54-16.

Identify opportunities to broadcast miscellaneous announcements such as:

- › Spot announcements
- › General paging
- › Landlord input in shopping centres
- › Adverts
- › Pre-recorded messages on a PC
- › Audio visual presentations

## Background music and entertainment

Does the system need music? If so, how many sources and how is it to be routed?

Different areas of a building may need to be linked to entertainment systems.

You need to identify the type and location of the music source e.g. multimedia player, PC etc.

# Voice Alarm and Public Address

## What messages do I need to meet the needs of the building?

Recommended messages are defined in the standards, and meet the needs of most buildings. In some cases messages may be tailored to suit special applications and may even involve coded alerts to warn staff ahead of the public.

## Recommend sequence of message and tone

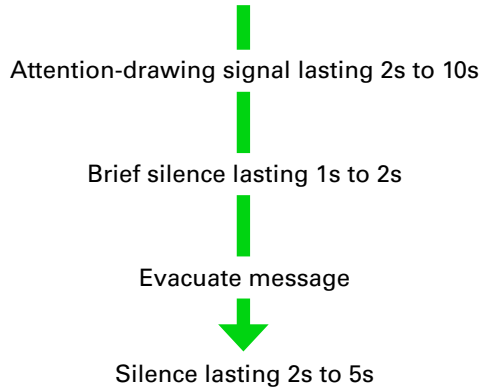

### Example of an evacuate message:

“Attention, please. Attention, please. Fire has been reported in the building. Please leave the building immediately, by the nearest exit. Do not use a lift.”

### Example of an alert message:

“May I have your attention, please. May I have your attention, please. Fire has been reported in the building. Please listen for further instructions.”

## System types

The system architecture may be selected to suit the building. Three main variations of providing voice messages are available today. These are:

- › Distributed Rack Systems
- › Centralised Systems
- › Wall Mounted Systems

All these types have possible use dependent on the type and size of the building where they are being installed.

## Distributed Rack Systems

Distributed Rack Systems allow multiple racks to be distributed across a building with each rack being networked together using a secure, fire-rated fibre optic ring.

## Centralised Rack Systems

Centralised Rack Systems consist of a rack of control equipment and amplifiers that control all the loudspeaker circuits that are radially wired. This rack can also contain facilities for zone selection, music input, emergency and general paging announcements. Considerations when using Voice Alarm systems:

- › The link between the fire control panel and the rack must be fully protected and monitored
- › The correct cables and sizes must be provided for the loudspeaker circuits particularly if they extend across many floors
- › The battery standby capacity must be properly calculated with some capacity to extend in the future

## Loudspeaker design – what you need to know...

### Which loudspeaker should I use?

There are potentially several ways of providing intelligible coverage for any particular space. The selection of the type, quantity, location and orientation of loudspeakers is a critical part of Voice Alarm System design and is based on information about the use of the building such as:

- › Acoustic environment
- › Floor plans
- › Building sections
- › Material finishes
- › Reverberation time
- › Ambient noise level
- › Climatic environment
- › Area coverage requirement
- › Mounting arrangements, for example ceiling tiles, wall, pole etc.
- › Architectural design and relevance of the appearance of the loudspeaker
- › Type of broadcast, i.e. if it is used for purposes other than voice alarm, such as commentary, background music etc.
- › Inter-relationship between loudspeaker zones and fire compartments

In line with BS 5839-8:2023 Section 13.3 loudspeakers should be chosen primarily for their ability to present an acoustic result rather than their aesthetic appearance such as size or appearance.



# Voice Alarm and Public Address

## Loudspeaker layout/placement

The best loudspeaker layout should give an even spread of sound within a room. This may mean using more loudspeakers at lower sound pressure levels rather than one very loud one.

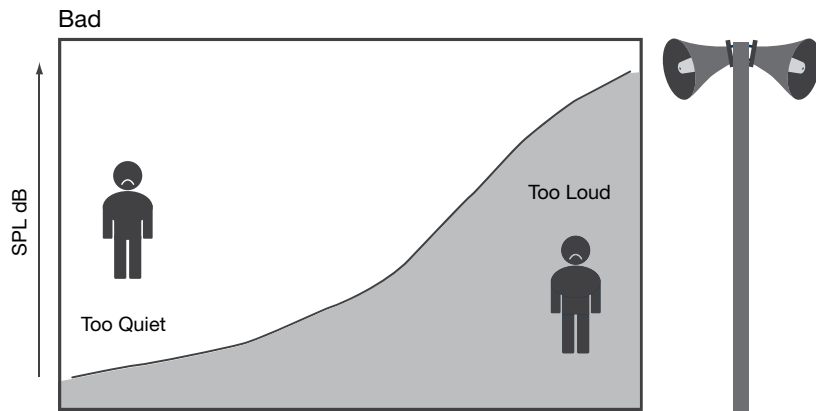

A single loudspeaker at a high setting will give a poor sound distribution. A number of loudspeakers distributed evenly will give a better distribution and a better quality of sound.

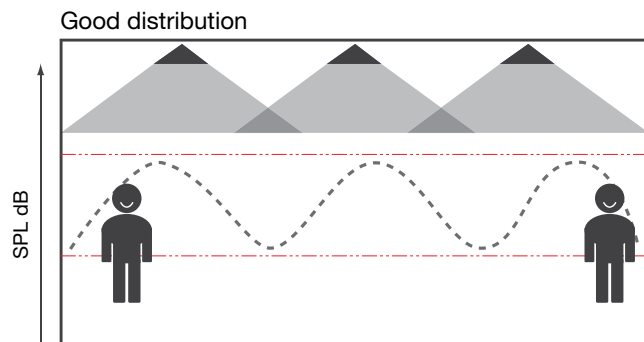

## Checklist – for loudspeaker design

BS 5839-8:2023 takes a more prescriptive approach than in previous editions providing simple loudspeaker spacing guidelines for designers.

In simple acoustic spaces, a competent person can estimate types, quantities and locations of loudspeakers required, using the above information.

It is recommended that the distance between the centres of each speaker should be no more than 6 metres for uni-directional speakers or 12 metres for bi-directional speakers.

There is a straightforward sequence to follow to arrive at a suitable loudspeaker design:

- ✓ 1 Decide loudspeaker layout/placement
- ✓ 2 Select loudspeaker types
- ✓ 3 Define setting for each loudspeaker
  - ✓ 3.1 Assess background noise levels
  - ✓ 3.2 Decide spacing and tapings
  - ✓ 3.3 Calculate SPL required from loudspeaker
  - ✓ 3.4 Calculate loudspeaker load

# Voice Alarm and Public Address

## Loudspeaker layout

A distributed system will suit most common applications:

1. Offices
2. Shell and core building systems
3. Classrooms
4. Shop units

Loudspeakers spaced at regular intervals deliver an even distribution of sound at ear level. Listener ear level should be higher than 1.2m unless it's a child or very small person.

Plan view with ceiling loudspeakers

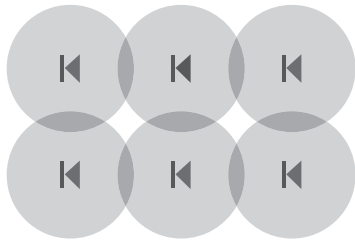

End view of ceiling loudspeakers

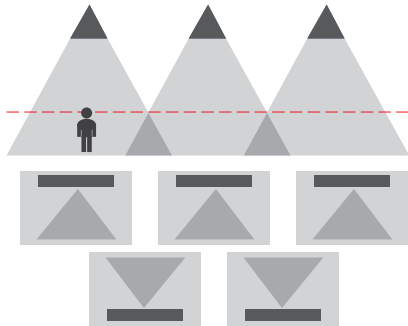

Wall loudspeakers may be used as an alternative distributed layout for high ceiling areas.

## Centralised design and hybrid or combined design

### Centralised design

In certain circumstances a centralised design is better suited for example in large open areas.

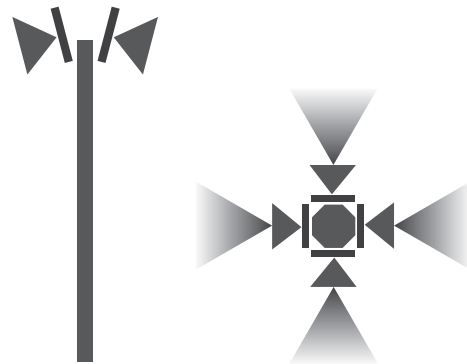

### Combined

In other circumstances a hybrid of centralised and distributed layout may be required.

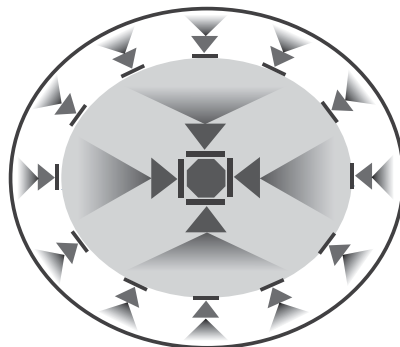

## Loudspeaker selection

### Ceiling loudspeakers

This type of loudspeaker is ideal for open plan offices with false (suspended) ceilings.



Ceiling loudspeakers can give very good music reproduction and are often used in 'low level multipoint' systems where each loudspeaker is tapped at a low level to provide a smooth and even distribution of sound throughout the area of coverage.

Installations with a large number of ceiling loudspeakers (in an open-plan office, for example,) will have them set in a grid pattern to maximise the coverage provided. Ceiling loudspeakers come in a range of diameters and tapping options from a standard 6 watt speaker to a full range 100 watt speaker.

### Cabinet loudspeakers

A cabinet loudspeaker provides general coverage within a room of limited size.



Cabinet loudspeakers are suitable for paging announcements in small, quiet offices. Alternatively a number of suitable cabinet loudspeakers can be used in larger office areas to provide sufficient coverage. Cabinet loudspeakers may also be used as ceiling loudspeakers where a suspended ceiling is not available.

### Horn loudspeakers

Horn loudspeakers have two main attributes: they are weatherproof and are able to direct sound in a well defined pattern. Compact and sturdy 're-entrant' types (folded internally to make the unit shorter) are the most common types.



Due to their restricted low-frequency response, they should be used only for speech applications and amplifier high-pass filtering must be selected. If horn loudspeakers are fed with low frequencies there is a risk of damage to the loudspeaker diaphragms.

### Projector loudspeakers

Projectors are more directional than cabinet loudspeakers but have better musicality than a horn.



The highly directional characteristic of projectors can be useful in saving amplifier power, in areas such as railway stations, a noisy machine shop, car parks and shopping centres.

### Column loudspeakers

Column loudspeakers consist of a number of drive units arranged in a vertical pattern and are usually confined to sound reinforcement applications rather than distributed P.A. systems.



They are designed to have a very wide sound dispersion (radiation pattern) in a horizontal plane (from side to side) and narrow dispersion in the vertical plane.

This makes them effective in areas with difficult sound characteristics such as churches, auditoriums, railway stations and airports.

### Spherical loudspeakers

Ideal for open areas with high ceilings such as retail units. Sound is distributed around 360 degrees and the sphere is suspended at a convenient height above the floor.

With good sound reproduction quality they are useful for voice and music in difficult applications.

# Voice Alarm and Public Address

## Siting of ceiling loudspeakers

For simple acoustic spaces, the distance between the centres of loudspeakers should not be greater than 6m for unidirectional loudspeakers and 12m for bi-directional loudspeakers.

In addition, the unobstructed distance between a loudspeaker and any listener should not be greater than 6m for unidirectional loudspeakers and 7.5m for bi-directional loudspeakers.

When using wall mounted cabinet loudspeakers, take care not to position loudspeakers opposite each other as the sound coverage and intelligibility in the area mid-way between them is likely to be very poor.

As general guidance, in rooms less than 6m wide, cabinets can be fitted along one wall only. Above 6m the loudspeakers should be fitted to opposing walls.

For larger, more complex or acoustically difficult spaces, specialist acoustic modelling and design should be employed in order to ensure a clear, intelligible message.

## Define loudspeaker settings

As well as layout, an intelligible Voice Alarm System is dependent on the sound level of the broadcast message.

## Calculating sound pressure level (SPL) required from each loudspeaker

### Step 1: Assess background noise

The Sound Pressure Level (SPL) required depends greatly on the background noise levels. Typically the system design should aim to deliver SPL at around 10dB above ambient. The table below gives some typical sound levels in different environments.

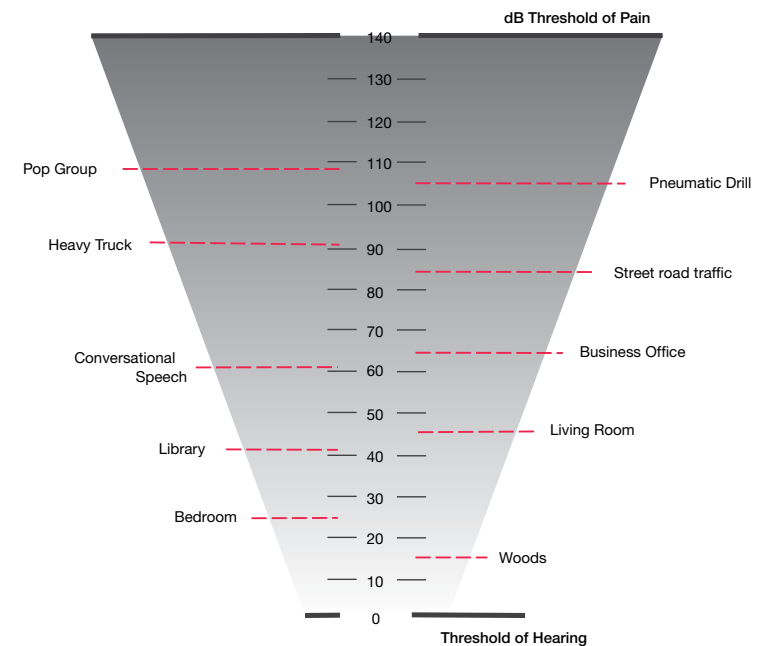

# Voice Alarm and Public Address

## Step 2: Sound pressure level

Sound pressure falls off rapidly with distance. For sound level measured at 1m, there is a loss of 6dB every time the distance doubles. To achieve the desired sound pressure at a certain distance away from the loudspeaker, the loss must be calculated.

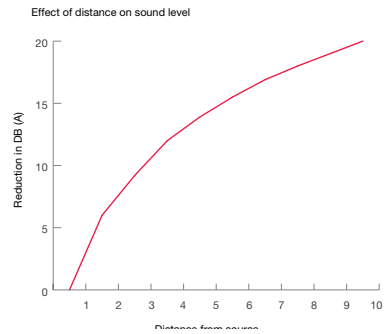

Distance from source (m)	Reduction in DB (A)
1	0
2	6
3	9.2
4	12
5	13.9
6	15.5
7	16.9
8	18
9	19
10	20

### Example

Distance from loudspeaker = 4m  
 Ambient noise level = 61dBA  
 Target SPL (6db+10db) = 71dBA

DB loss over 4m = 12dBA  
 Loudspeaker setting at 1m = At least 83dBA@1m

## Step 3: Loudspeaker tapping

Once the sound pressure level is known, the tap setting of the loudspeaker can be defined.

Loudspeaker data sheets give the power needed to achieve the SPL at 1m.

The table below can also be used to define typical tap settings for ceiling loudspeakers at different ceiling heights.

### Typical tap settings

Ceiling height	Background Noise (SPL set to 10dB higher)					
	65dB	70dB	75dB	80dB	85dB	90dB
2.5	0.75	0.75	0.75	0.75	1.5	6
3.0	0.75	0.75	0.75	1.5	3	-
3.5	0.75	0.75	0.75	3	6	-
4.0	0.75	0.75	1.5	6	-	-
4.5	0.75	0.75	3	6	-	-
5.0	0.75	0.75	3	-	-	-
5.5	0.75	1.5	3	-	-	-

## What size amplifier do I need?

### Calculate loudspeaker load for each circuit

Once you have determined each individual loudspeaker tapping, the total load for each loudspeaker circuit can be calculated. By adding the power requirement for every loudspeaker the total load for the Amplifier is calculated.

Add 20% for minimum size of amplifier needed (account for efficiency losses on amplifier and cable).

Losses of the cable would be controlled by correct sizing (cross sectional area) and amplifiers are now very efficient. The 20% contingency comes from BS 5839-8:2023 as a minimum spare capacity for amplifiers to cover additions and changes during commissioning.

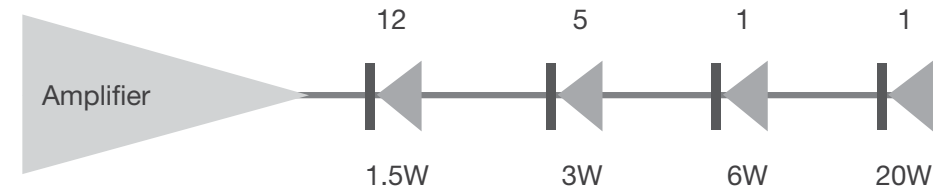

$$(12 \times 1.5 \text{ W}) + (5 \times 3 \text{ W}) + (1 \times 6 \text{ W}) + (1 \times 20 \text{ W}) = 59 \text{ W load}$$

$$+ 20\% = 12 \text{ W}$$

$$\text{Total Power} = 71 \text{ W}$$

# Voice Alarm and Public Address

## Example systems from Notifier

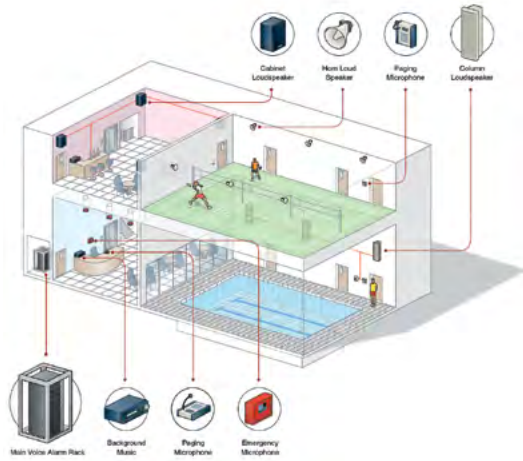

### Stand alone

An easy to install VA/PA solution. Suitable for small to medium buildings.

### Applications

- › Leisure complexes
- › Schools
- › Small hotels
- › Theatres
- › Offices

### Benefits

- › Easy to install
- › Small and compact
- › Ensured compliance to BS/EN standards

## Custom made

Need an advanced VA/PA solution for your building? Our custom made Rack Systems cater for all types of buildings. Suitable for medium to large sites.

### Applications

- › Shopping centres
- › Stadiums
- › Transport hubs
- › Large office complexes

### Benefits

- › System capable of supporting a large number of evacuation and/or paging zones
- › Capable of managing complicated evacuation strategies in the event of an emergency
- › Ability to prioritise multiple audio inputs and outputs (Microphones, background music etc.)
- › Ensured compliance to BS/EN standards

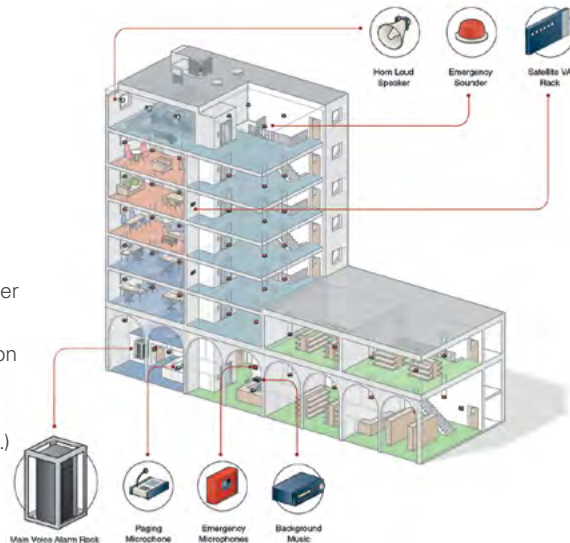

## Scalable

Our VA/PA systems can be networked together to deliver the most comprehensive and powerful solution for a wide range of applications. Suitable for large and complex sites.

## Applications

- › Universities
- › Airports and transport hubs
- › Exhibition halls
- › Shopping centres
- › Large office buildings

## Benefits

- › High bandwidth for large sites
- › Scalability and modular to adapt to constant changes and demands
- › IP connectivity to link multiple sites to one control or command centre
- › All system sizes network ready

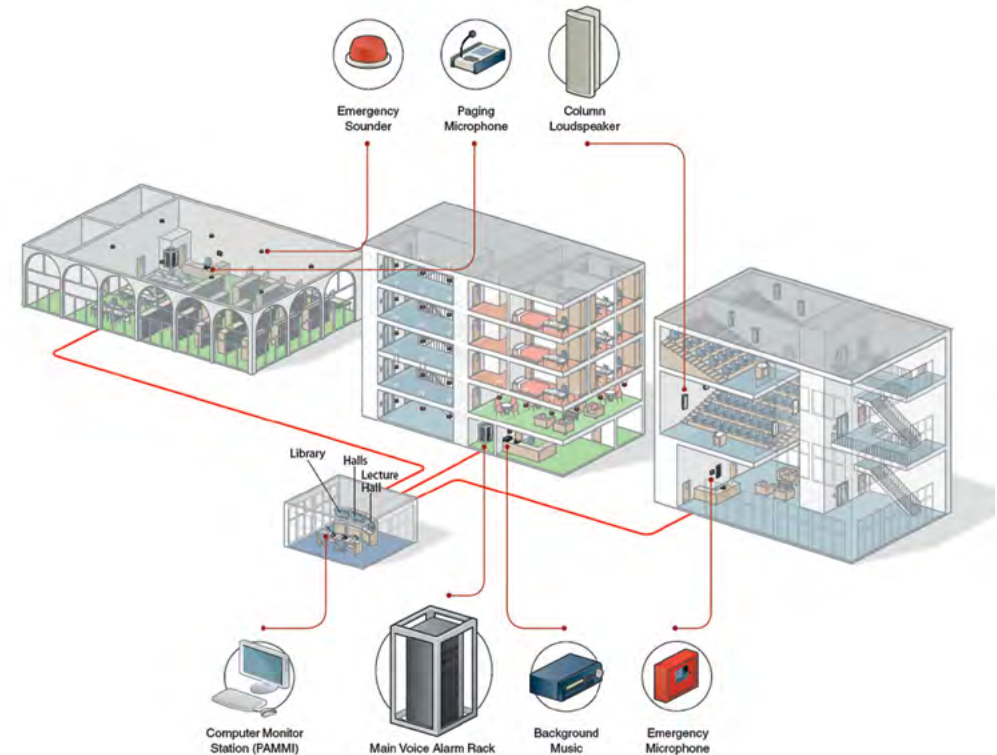

# One Solution For Your Holistic Notification Needs: Variodyn One

**VARIODYN ONE Public Address and Voice Alarm system is a harmony between technology, design and performance.**

VARIODYN ONE is an **IP-based Public Address and Voice Alarm (VA/PA)** system that delivers exceptional usability and sound performance to address daily operational and safety needs of a building. It is the next generation of the trusted VARIODYN product line, which is used in some of the largest and most complex installations across the world. It is the foundation of Honeywell's new global notification platform that can better inform building occupants of activity in a building – from daily announcements to emergency response directions.

VARIODYN ONE can support a wide range of applications: Airports, Railway Stations, Stadiums, Hotels, Shopping Centres, Education Complexes, Hospitals and Industrial Plants.

## Variodyn One system components

### INC (Intelligent Network Controller)

INC is the main controller of the VARIODYN ONE VA/PA system. It is responsible for managing and monitoring all key components of the system including power amplifiers, speaker lines, call stations, etc.



### Power amplifiers

You can choose between our new fixed power output amplifiers with inbuilt battery charger or our new amplifiers with Power Sharing technology that provides you the flexibility to define power output dynamically per channel.

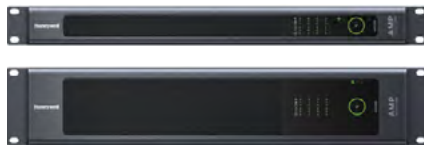

### ETCS (Ethernet Touchscreen Call Station)

ETCS is an EN54- 16 certified touch screen call station with a big clear screen and unique features. Direct connectivity to the ethernet network provides flexibility to change the location or install a new call station at any stage of the project. This small power full device is packed with features to ensure ease of operation and maintenance of your VARIODYN ONE system.



### DCS PLUS call station

DCS Plus call station with its simplistic and elegant design ensures that you are able to perform your key day to day functions like paging, volume control, intercom etc without any hassle. It has 12 freely programmable keys to ensure that you define the functions that are best suitable for your project. With the capability to add 6 additional DKM-18 modules with 18 keys each, you can expand the total number of keys to 120 to ensure that you can serve a small building to a large complex with a single DCS Plus call station.



### UIM (Universal Interface Module)

The UIM serves as the interface module of the VARIODYN ONE PA/VA system for connecting two analog audio inputs, two analog audio outputs, as well as 48 control contacts. For eight control contacts, short-circuit and interruption monitoring can be activated.



### PSU (Power Supply Unit)

PSU is an integral part of a Public Address and Voice Alarm system. VARIODYN ONE offers two different power supplies to choose from depending on what meets your project requirement. All our Power supplies are certified according to EN54-4/A2.



### MSU (Mains Switching Unit)













The MSU is used to secure the power supply of all VARIODYN ONE components that are installed in a rack. In addition, it offers a connector for connecting a service PC for local/network-wide maintenance purposes. All connected PA/VA system components can be switched ON or OFF by using the switches. On detecting a short circuit or an overload, protective function is automatically triggered, and the connected PA/VA system components are disconnected from the power supply.



# Voice Alarm & Public Address



## BS EN 54-24 Honeywell approved loudspeakers

	Part Number
 6 watt Ceiling Loudspeaker 5"	LSC-506
 6 watt Ceiling Loudspeaker 6" C/W Capacitor	LSC-606/DC
 24 watt Coaxial Ceiling Loudspeaker	582480
 6 watt Cabinet Loudspeaker	582470
 6 watt Round Cabinet Loudspeaker	582423
 15 watt Horn Loudspeaker	582479
 30 watt Horn Loudspeaker	582432
 20 watt Bi-directional Projector Loudspeaker	582475
 10 watt Uni-directional Projector Loudspeaker	582473
 20 watt Uni-directional Projector Loudspeaker	582474
 20 watt Column Loudspeaker	582476
 40 watt Column Loudspeaker	582477



# Lithium-Ion Battery Off-Gas Detection

Li-ion Tamer reliably detects the early signs of failing Lithium-Ion Batteries (battery electrolyte vapours – off-gas detection) allowing facility managers to respond to impending Thermal Runaway events at the earliest detection.

# Li-ion Tamer Gen 3



The Li-ion Tamer GEN 3 system is highly scalable and can be configured for cost effective protection for a wide range of lithium-ion battery storage installations.

It provides multi-point temperature and humidity measurements for improved situational awareness/ environmental control and its simplified installation (daisy-chain connections between sensing nodes) reduces cabling material and setup time.

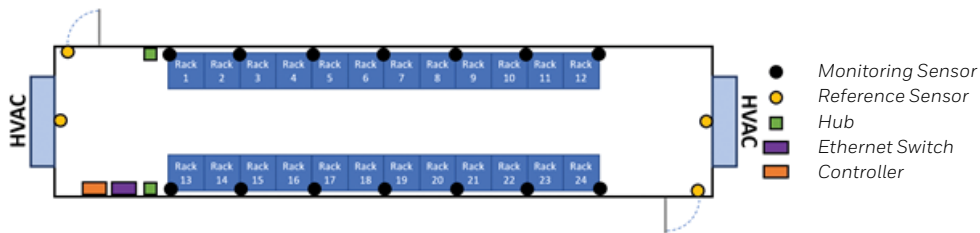

## Key features

- › Early warning of lithium-ion battery failures - enable thermal runaway prevention with proper mitigating actions
- › Single cell failure detection without mechanical or electrical contact to the cells
- › Scalable deployment for cost-effective protection of a wide range of battery storage systems
- › Temperature and humidity monitoring at each sensing node
- › Extended product lifetime
- › Calibration-free product with highly reliable output signal
- › Compatible with all lithium-ion battery form factors and chemistries
- › Easy installation
- › Independent and redundant perspective on battery health
- › Auto diagnostic capabilities
- › Reduction/removal of false positive signals

Part Number	Description
LT-SEN-M3	Sensor Monitoring LT Gen 3
LT-SEN-R3	Sensor Reference LT Gen 3
LT-CTR-SML	Ctr Small LT Gen 3
LT-CTR-SML-DMK	Ctr Small DIN-Mount Kit LT Gen 3
LT-ACC-SAK	Spare 4xTerminators 1xScrew Adapter
LT-ACC-HUB-POE-HON	Hub PoE LT Gen 3 - Honeywell
LT-ACC-HUB-PWR-HON	Hub Direct Power LT Gen 3 - Honeywell
LT-ACC-HUB-MKT	Hub DIN-Rail Mount Kit
LT-ACC-ETS-16	Ethernet Switch 16 port
LT-ACC-ETS-5	Ethernet Switch 5 port
LT-ACC-ETS-8	Ethernet Switch 8 port
LT-ACC-POE-24	Ethernet Switch PoE, 24 ports
LT-ACC-POE-4	Ethernet Switch PoE, 4 ports
LT-ACC-POE-24-ADR	PoE Switch 24 port, IEC Power Adapter
LT-ACC-NCL-10	RJ45 Cable 10' LT Gen 3
LT-ACC-NCL-100	RJ45 Cable 100' LT Gen 3
LT-ACC-NCL-25	RJ45 Cable 25' LT Gen 3
LT-ACC-NCL-3	RJ45 Cable 3' LT Gen 3
LT-ACC-NCL-5	RJ45 Cable 5' LT Gen 3
LT-ACC-NCL-50	RJ45 Cable 50' LT Gen 3
LT-ACC-PWR-12	Power Supply 12VDC
LT-ACC-PWR-48	Power Supply 48VDC
LT-ACC-ERO-16	Ethernet Relay Output 16 port
LT-ACC-ERO-MKT	Relay Output DIN-Rail Mount Kit
LT-ACC-TST	DEC Bump Test Bottle



# EVCS – Emergency Voice Communication Systems

This section is aimed at supporting designers on Emergency Voice Communications Systems. 'Emergency Voice Communication System' is the generic technical term to cover 'Fire Fighting Telephone Systems' and 'Disabled Refuge Communication Systems'.

It highlights some of the main considerations in system design and gives an overview of the Legislation and codes of practice governing the use of EVC Systems.

## Legislation and Codes of Practice

- › The Equality Act 2010
- › Building Regulations; Approved Document B
- › Building Regulations; Approved Document M
- › Section 4 of Non-Domestic Technical Handbook (Scotland)
- › Technical Booklet R under the Building Regulations (Northern Ireland) 2000
- › BS 8300:2009 – Design of buildings and their approaches to meet the needs of disabled people
- › BS 9999:2017 – Fire Safety in the Design, Management and use of Buildings
- › Regulatory Reform (Fire Safety Order 2005)
- › BS 5839-9:2021 – Design, installation, commissioning and servicing of EVC systems

# EVCS

## What is an EVC System?

An EVCS (Emergency Voice Communication System) is a fixed, monitored and maintained, bi-directional, full-duplex voice communication system to assist the orderly evacuation of disabled or mobility-impaired people and enhance the Firefighter's communication during emergencies.

## Intended uses for EVC systems

In the first stages of evacuation, before the fire and rescue service arrives, the EVCS may be used between the control room and, for example, fire wardens/marshals on various floors or stewards at a sports venue. Typically, a call can be made from a floor to advise the control centre that the floor has been cleared.

The fire and rescue service would normally take control of the evacuation upon arrival at site, with a fire officer at the control centre communicating with other officers via the EVC system.

During the course of a fire, the fire and rescue service would continue to use the EVCS to assist firefighting.

Use by disabled persons, particularly during a fire, but also in other emergency situations. A disabled person or anyone who is not able to use an escape route would be able to identify their presence and communicate with the control centre.

## Disabled refuge

A Disabled Refuge area is a relatively safe place where people who cannot easily use fire escapes and evacuation lifts can call for assistance

and wait while the main building occupancy is evacuated. This allows building management and emergency services to safely assist these people from the building when stairwell crowding has eased. Simple, effective two-way communication (Refuge system) in these areas is essential; firstly to assist rescue teams in determining where assistance is required, and secondly to reassure people that help is on the way.

Mobility impairment is defined as not being able to walk 200m continuously without aid, and includes arthritis sufferers, people with leg and back injuries and women over six months pregnant.

## When is a disabled refuge required?

Disabled Refuge systems are required in the UK in all non-domestic premises over one storey or where an emergency exit is by stairs (for a full description see building regulations approved document B). More generally as required by the appropriate regulation and/or a fire risk assessment, particularly where there are disabled people or people who may have difficulty negotiating the evacuation route.

From April 1 2001, maintained schools ceased to have exemption from building regulations and all schools greater than a single storey should have an EVC System.

Purpose-built student living accommodation including that in the form of flats, should be treated as hotel/motel accommodation in relation to space and facilities required.

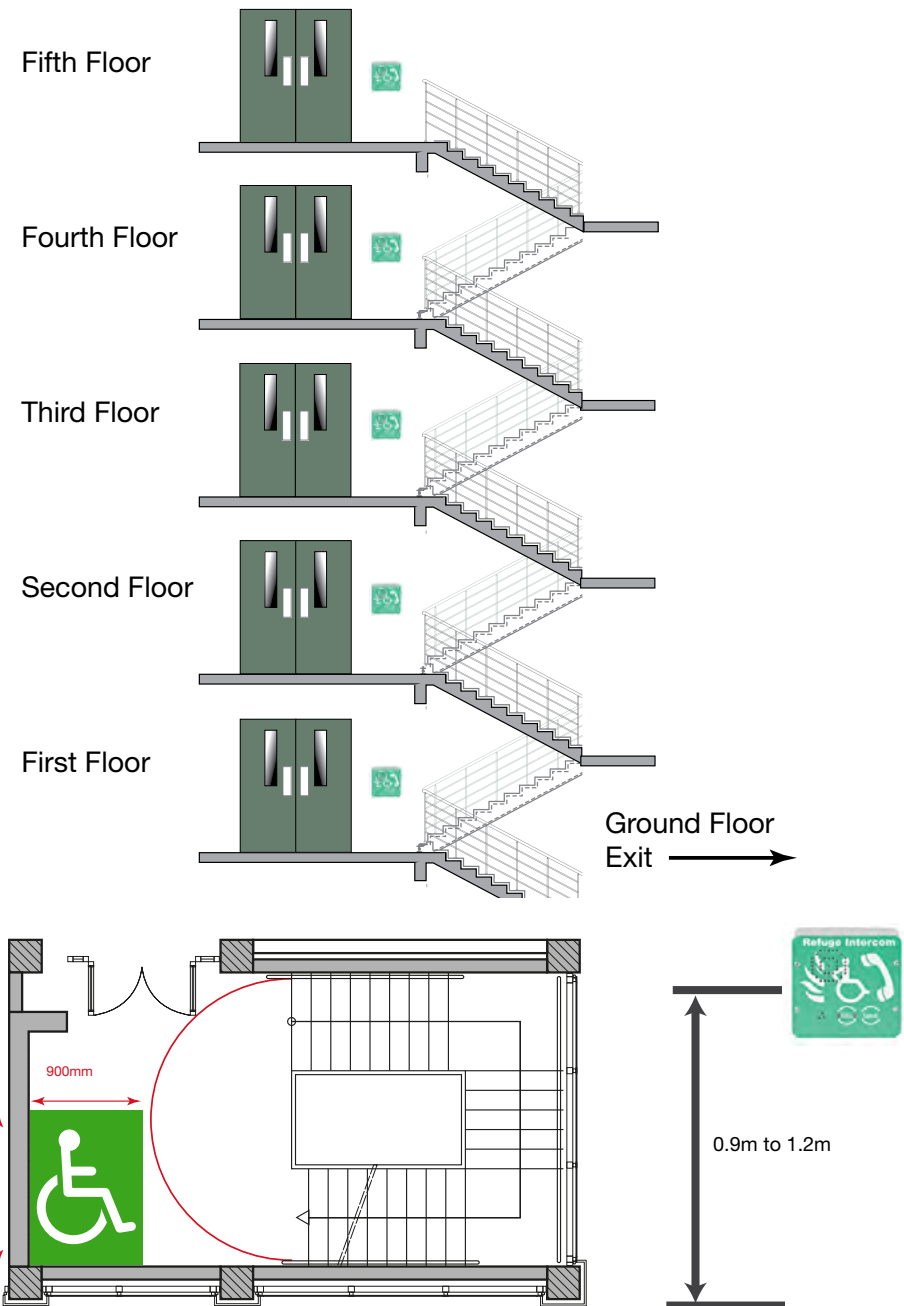

# EVCS

## Where should disabled refuges be placed?

A Disabled Refuge should be provided for each stairway. It need not always be located in the stairway but should have direct access to a Stairway. Each refuge should provide an accessible area to a wheelchair of at least 900mm x 1400mm and the wheelchair should not reduce the width of the escape route. Refuge spaces need not equal number of wheelchair users. If steps are located at final exit then an outstation is required.

A Disabled Refuge system is not just for use during a fire, must be available at all times and **MUST NOT BE DISABLED OUTSIDE OF A FIRE EMERGENCY** (for a full description see building regulations approved document B).

Refuges and evacuation lifts should be clearly identified with appropriate fire safety signs and when a refuge is in a lobby or stairway the sign should also have a mandatory blue sign worded 'Refuge – Keep clear'.

Refuge outstations should be wall mounted between 0.9m and 1.2m above the ground in an easily accessible, well-lit position with low background noise.

## Fire telephone systems

Fire telephones are hardwired full duplex communications systems with monitoring and battery back-up, and are required in buildings over 4 stories in many countries in the world (in the UK this is governed by BS 9999). These are provided as a back-up to traditional fireman's

radio systems, which can fail to operate in many high rise environments due to the large amount of steel in the building, and the 'corona' effect of fire on radio broadcasts. When both disabled refuge and fire telephone systems are installed in a building they should form a single system.

Fire telephones are also required in fire fighting lift lobbies when these lifts are provided within a building. Fire telephones can also be used for fire wardens to call the control point during fire drills and primary evacuation phases before the fire and rescue services arrive and assume control.

They should also be installed in buildings when the shape, size or type requires communication between remote locations and the central control point such as in sports venues, to assist stewards in controlling the evacuation.

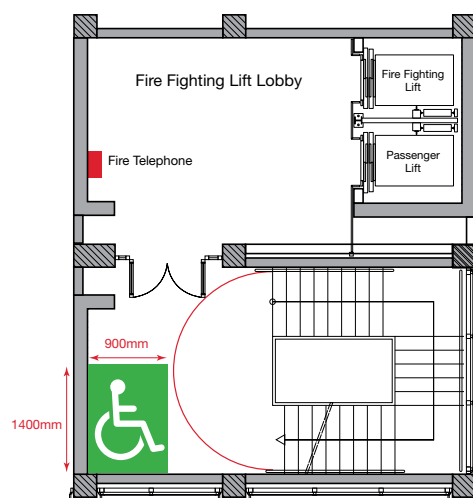

## Where should fire telephones be placed?

In tall buildings with phased evacuation, an internal speech communication system should be provided for speech between a control point and rescue services on every storey.

Type A outstations should be located at every fire fighting entrance point, fire escape landing and fire fighting lobby. They should be wall mounted 1.3m to 1.4m above ground, easily accessible in well-lit and low background noise.

In sports stadiums, outstations should be no more than 30m from a stewards position or other normally manned area e.g. turnstile, police rooms and senior officials.

## Emergency assist alarm

An Emergency Assist Alarm is defined in 'Building Regulations Approved Document M', and must be provided at all disabled toilets within a non-domestic premises. If the toilet is in a non-permanently occupied space, remote indication must be provided at a central control or monitoring point. An emergency assist alarm can only be reset by attending the location of the call, so the reset point is within the cubical, also allowing accidental calls to be cancelled by the toilet occupier.

The emergency assist alarm should be fully monitored in line with the specification described in BS 8300-2:2018.

It has now become very common for the disabled toilet to be specified as part of the refuge system, and by integrating it with the Emergency Voice Communication System all calls relating to disabled communications can be displayed in a single point.

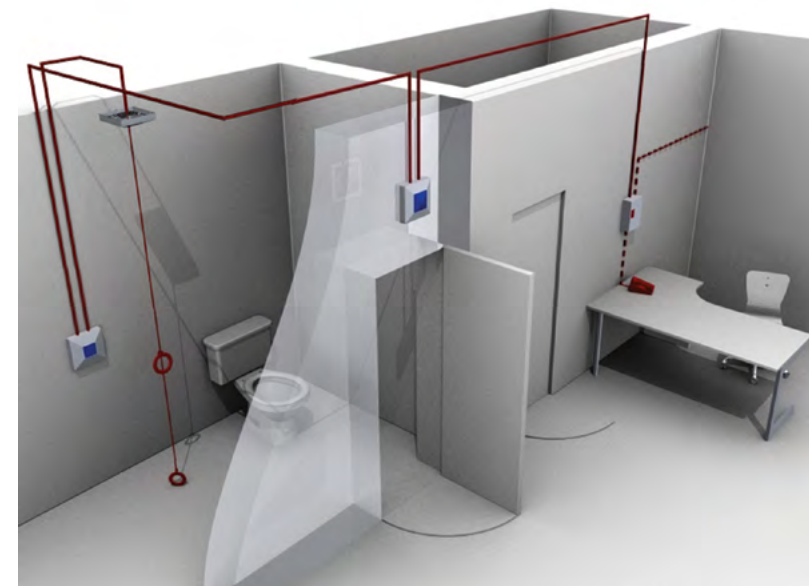

# EVCS

## Cabling requirements

Following the publication of BS 5839-9:2021, the guidance on cables for the EVCS has changed, following a relaxation in the requirements of the standard.



### Fire fighting telephone systems

Any system with Fire Fighting Telephones (Normally Type A Outstations) must have all wiring to these outstations and any necessary network cables interconnecting parts of the system in enhanced fire rated cables.



### Disabled refuge systems

In buildings under 30 metres in height, or any building with sprinklers fitted, the wiring of Disabled Refuge points (normally Type B Outstation) may be in standard fire rated cable as long as the planned evacuation will be completed within 30 minutes.

If the building is over 30 metres in height without sprinklers, or where the evacuation will take place over multiple stages exceeding 30 minutes, enhanced fire rated cables must be used.

Network cables for systems comprising of purely Disabled Refuge Outstations configured as a ring may also be in standard fire rated cables.

In BS 5839-9:2021 section 14, the commentary suggests that in an EVCS intended for only Disabled Refuge the use of standard fire resistance cable may be acceptable provided the period specified for evacuation of the building is less than the fire rated duration of the cable.



### Disabled toilet call points

The revised BS 5839-9:2021 now recognises the addition of disabled toilet call systems to EVCS, however it gives no guidance on their use, as this is covered under 'Building Regulations Approved Document M'.

There is no requirement for these systems to be monitored or battery backed. However, with the EVCS toilet extension we have included these features as standard. The only cable requirement may come from the building design statement, and typically this will require low smoke and fume cables (LSF), although they can also be wired in standard fire rated cable for ease of identification.

## Combined systems

When a system consists of a mix of Fire Fighting Outstations, the wiring must be enhanced, but individual spurs to Outstations dedicated solely for Disabled Refuge may be wired in standard fire-rated cable as long as the distance covered by that cable does not exceed 30 metres vertically in non-sprinklered buildings, or the evacuation plan for this segment of the building will not exceed 30 minutes.

## General guidance

In complex buildings or where systems are being quoted without access to the fire evacuation plan we recommend all wiring to be enhanced, or suitable caveats and detailed assumptions are placed on the design certificate required by BS 5839-9:2021.

## Interconnection of EVC systems

**A RADIAL-WIRED SYSTEM** where if a cable fault occurs, individual fault indication should be given related to the affected radial link.

**A SINGLE OR MULTIPLE LOOP** configuration may be used – emergency voice communications must continue to take place between ANY outstation and the master handset in the event of an open circuit fault, fault monitoring is also recommended.

## Siting of master handset

The EVC system master handset(s) should be located:

- › Close to the main fire alarm panel or a repeater fire panel
- › Preferably in a manned control or security room
- › In an area of low fire risk
- › In an area with low background noise, particularly during an emergency

## Power supply











BS 5839-9:2021 – 13.1b. The mains supply circuit(s) to all parts of the EVCS except outstations should be dedicated solely to the EVCS, and should serve no other systems or equipment. The circuit(s) should be derived from a point in the building's electrical distribution system close to the main isolating device for the building.





The EVC system power supply should:

- › Be supplied from an isolating protective device
- › Dedicated solely to the supply of the EVC system and serve no other systems or equipment
- › Should indicate any faults at the master handset
- › Be provided with a warning label
- › Will have sufficient battery capacity to maintain the system in a quiescent state for at least 24h and then allow voice communications for at least 3h
- › When automatic standby generator is provided the above is reduced to 3h in quiescent state and 3h voice communications

# EVCS

## Product range at a glance

	Part Number
	Network 16 Master Panel EVCS-MPX-16
	Network 16 Network Slave Unit ( 16 Additional Loop Outstations) EVCS-NSX-16
	Digital Type A Handset EVCS-HSA-RS-D
	Digital Type A Handset-Stainless Steel EVCS-HSA-SS-D
	Digital Type B Outstation-Green Surface EVCS-CSB-GS-D
	Digital Type B Outstation-Green Flush EVCS-CSB-GF-D
	Digital Type B Outstation-Red Surface EVCS-CSB-RS-D
	Digital Type B Outstation-Red Flush EVCS-CSB-RF-D
	Digital Type B Outstation-Surface Stainless Steel EVCS-CSB-SS-D
	Digital Type B Outstation-Flush Stainless Steel EVCS-CSB-SF-D
	Compact 5 Master Handset EVCS-CMPT

	Part Number
	Jack Type Additional Plate-Flush Stainless Steel EVCS-WJPPSF-D
	Emergency Assist Alarm Stand Alone Kit EVCS-TAP
	Emergency Assist Alarm Kit (without PSU) EVCS-TA
	Emergency Assist 4 Way Splitter EVCS-TASP
	Power Supply for 4 Way Splitter EVCS-TASP4-P



# Paging Systems

Linking a Paging System to a Fire Detection and Alarm System can bring real benefits. Not only can they be used as a portable repeater, displaying alert messages from the main fire panel, but they can have a key role to play when considering the needs of the hearing impaired in an emergency situation.

## Legislation and Codes of Practice

- › The Equality Act 2010
- › BS 5839-1:2017, Paragraph 18 – Fire Alarm Warnings for the deaf and hard of hearing
- › BS 8300:2009 – Design of buildings and their approaches to meet the needs of disabled people
- › BS 9999:2017 – Fire Safety in the Design, Management and use of Buildings

# Paging Systems

## Remote fire messaging

The use of a Paging System provides a cost-effective and flexible solution for quickly identifying, validating and responding appropriately to activated alarms.

Unnecessary evacuations have a significant impact on commerce and industry in terms of interrupted productivity, downtime and loss of revenue. They are also a considerable drain on the resources of the Fire and Rescue Services both in terms of lost time and costs.

- › Save money and time by reducing evacuations through quickly identifying triggered alarms
- › Improve response times by enabling personnel to identify the exact location of an alarm
- › Sustain productivity, output and sales through the avoidance of unnecessary evacuations
- › Enhance safety by improving the coordination of evacuations
- › Build better relationships with the local fire authority

### System architecture



Fire marshal receives alert with precise detail of incident location

## Remote warning for the deaf and hard of hearing

A Paging System provides an easy-to use, cost-effective solution to support deaf and hard of hearing people in case of a fire emergency. In compliance with the Equality Act 2010, recommends that these devices send a strong vibration to every pager together with a text message, to alert the user of a fire evacuation.

- › Improves your duty of care and welfare of your customers and staff
- › Ensures safer, simpler and quicker evacuations
- › Easy to use with clear and simple fire alert instructions
- › Reduces the risk associated with evacuating deaf and hard of hearing people
- › Provides independence and reassurance to those unable to hear fire alarms

### System Architecture



Deaf or hard of hearing occupant receives vibrating alert with alarm text message to ensure they are aware of an evacuation

## Equality act – risk assessment

- › The transmitter must be able to send multi-vibration to the pager
- › The transmitter needs to be monitored and report failure to the fire panel
- › The transmitter must have battery back-up for 24 hours
- › The units must alert the fire panel when there is a power supply failure
- › The unit must alert the fire panel when there is a battery back-up failure
- › The connection from the fire panel is to be contact closure
- › The unit should NOT be used for other functions
- › The page must vibrate for 1 minute continuously
- › The pager must not be able to be switched off easily
- › The pager should vibrate if it goes out of range of the transmitter
- › The system should be health-checked twice a year.

# Paging Systems

## Adherence to BS 5839-1:2017

### Paragraph 18 – fire alarm warnings for the deaf and hard of hearing

There are no British Standard specifications for alarm devices for the deaf and hard of hearing available at present in the UK. Nevertheless, wherever possible, the recommendations of clause 18.2 should be followed and any variations ought to be subject to a risk assessment to ensure that no deaf or hard of hearing person is exposed to undue risk.

As required by UK and EC law, radio paging equipment should comply with the European R&TTE Directive, EMC Directive, Low Voltage Directive and the ETS 300 224 radio paging specification.

Paging Systems specifically for the purpose of alerting the deaf and hard of hearing should be designed and installed to meet the relevant recommendations in BS 5839-1:2017, paragraph 18.2.

Paragraph 18.2.2 refers to the portable alarm devices used to supplement the primary means of giving an alarm of fire. The following recommendations should be considered:

- a. The alarm should be given at the portable alarm device within five seconds of the generation of the alarm signal at the fire detection and alarm control and indicating equipment.
- b. The alarm signal emitted by the portable alarm device should continue for at least 60 seconds after reception of every alarm signal or until

it is acknowledged at the alarm device. This emitted alarm signal may be intermittent.

- c. In a fire condition, the control equipment should continue transmitting the alarm signal to the portable alarm devices until the alarm is cancelled by a signal from the fire alarm control equipment. If the control equipment does not send the fire signal continuously, it is acceptable for the control equipment to send the alarm signal repeatedly at periods not exceeding 10 seconds.
- d. Where the portable alarm device is also used for other purposes (e.g. general paging), the recipient should be able to tell the difference between a signal of fire and a signal for other purposes.
- e. Where the portable alarm device is also used for other purposes (e.g. general paging), the fire signal should have priority over any other signal.
- f. A failure of the interconnection (e.g. radio transmission) between the control and indicating equipment and the portable alarm device should be identified at the portable alarm device by a visual and tactile signal within five minutes of the failure.
- g. Portable alarm devices may be operated from a single power source (e.g. battery). A low power source voltage should be identified at the portable alarm device by a visual and tactile signal.
- h. If a portable alarm device is fitted with an off switch, or a switch disabling the alarm signal, the design of the switch should be such as to avoid inadvertent operation.

- i. All faults identified at the control equipment for the portable alarm system should result in at least a common fault warning at the fire detection and alarm system control and indicating equipment within 100 seconds of the fault being identified at the portable alarm control equipment.

## System installation and set up

### Locating the equipment

Before locating the paging transmitter in any given location, it is important to take into account the range of the operation that is required.

A 4W transmitter can quite easily provide range of up to a mile or more (line of site) and will provide full coverage in most medium and large sites. However, a site survey is recommended to ensure adequate coverage.

Important: Coaxial feed greater than 5 metres must employ low loss 50 ohm coax. We normally do not recommend feeds of more than 15 metres for standard applications. However, we suggest you contact Sales Support for guidance and site survey.

### Location to Fire Alarm Control Panel

Direct RS232 serial data between the fire panel and the transmitter unit should be no greater than 15 metres in length of data cable. These cables should be screen/shielded and must be kept clear of sources of induced magnetic and electrical noise. In the event that distances are over 15 metres, additional drivers and amplifiers must be installed at both ends of the data link.

### Range testing

It is recommended that a range test is carried out to ensure that full site coverage has been achieved.















### Important installation notes

- a. Never install antennae near or adjacent to telephone, public address or data communication lines or overhead cables.
- b. Avoid, where possible, running antenna coax alongside other cables.
- c. Avoid mounting the transmitter in the immediate vicinity of telephone exchanges or computer equipment.
- d. Always use proprietary 50 ohm coaxial cable between antenna and the transmitter. If the cable runs exceed 5 metres, always use low loss 50 ohm cable such as RG213, UR67 or equivalent (coax cable intended for TV, Satellite or CCTV installation is normally 75 ohm and therefore unsuitable for any transmitter installation).
- e. Remember that the performance of the system will be affected by the type of material the unit is mounted in close proximity to. A transmitter signal will be adversely affected if mounted near: foil back plasterboard, metal mesh, wire reinforced glass, metal sheeting, large mirrors or suspended ceilings and lift shafts.
- f. **NEVER** transmit without an aerial attached to the transmitter.
- g. **ALWAYS** carefully check the installation section in the manual covering data pin connections prior to installation.

# Paging Systems

## Product Range at a Glance

		Part Number
<b>DDA/EQUALITY ACT HEARING IMPAIRED PAGING SYSTEM - COMPLIANT TO BS5389 EN54-4</b>		
	Response Aid Paging System V3 - Hearing Impaired System	HLS-RES-AI
	Response Dipole Antenna with 5mtrs cable	HLS-RES-ANT2
	Response Radio Paging Licence (5 Years)	HLS-RES-LICENCE
<b>DDA/EQUALITY ACT PAGERS</b>		
	Pager Black AA Battery ECA	HLS-RES-AAPAG-ECA
	Rechargeable SMARTCALL Alert Pager with Swiv Belt Clip	HLS-RES-PAG-DDA
	Rechargeable Pager 12-way Charger Rack with PSU	HLS-RES-CHAR12
	Rechargeable Pager 6-way Charger Rack with PSU	HLS-RES-CHAR6
	Rechargeable Pager TFT 15 Way Docking Station	HLS-RES-CHAR15
	Rechargeable Pager TFT Display Pager - Equalities Compliance Act Use	HLS-RES-PAG-ECA
<b>DDA/EQUALITY ACT PILLOW ALARM</b>		
	Response Aid Pillow Alarm with 2mtr Cable and Vibrating Pad, PSU	HLS-RES-PILLO-ALM
<b>FIRE MARSHALL PAGING SYSTEMS - BS5839 EN54-4</b>		
	Response Aid Paging System V3 - Serial Connection	HLS-RES-V3AI
	Response Dipole Antenna with 5mtrs cable	HLS-RES-ANT2
	Response Radio Paging Licence (5 Years)	HLS-RES-LICENCE
<b>TWO-WAY RADIO MESSAGING MODULE - SPECIAL ORDER</b>		
	Radio Module for Plus and Aid	HLS-RES-RADIO

<b>FIRE MARSHALL PAGERS</b>		
	Pager Black AA Battery Fire Marshall	HLS-RES-AAPAG-FIRE
	Rechargeable SMARTCALL Alert Pager with Swiv Belt Clip	HLS-RES-PAG-ALERT
	Rechargeable Pager 12-way Charger Rack with PSU	HLS-RES-CHAR12
	Rechargeable Pager 6-way Charger Rack with PSU	HLS-RES-CHAR6
	Rechargeable Pager TFT 15 Way Docking Station	HLS-RES-CHAR15
	Rechargeable Pager TFT Display Pager - Fire Marshall Use	HLS-RES-PAG-FIRE
<b>FIRE ALARM CONNECT TRANSCEIVERS</b>		
	Response Aid Paging System V3 - Fire connect	HLS-RES-V3AI
	Response Dipole Antenna with 5mtrs cable	HLS-RES-ANT2
	Response Straight Antenna	HLS-RES-ANT1
<b>REPEATERS AND AMPLIFIERS</b>		
	Response Plus/Aid 25 Watt Amp	HLS-RES-AMP
	Response Dipole Antenna with 5mtrs cable	HLS-RES-ANT2
	Response Straight Antenna	HLS-RES-ANT1
	Res. Aid Repeater - Battery & Monitored	HLS-RES-VREP-A1
	Res. Plus Repeater	HLS-RES-VREP-PL

# Central Battery Systems and Emergency Lighting



The design specification, selection and installation of emergency lighting is covered by an extensive range of legislation which is under continual review, being amended, in response to Directives and Standards issued by the relevant statutory bodies of the European Union. The first stage of system design is to gather all information for the project through reference to local authorities for current legislative Directives and Standards, and must pay due regard to users/customers preferences.

## Legislation and Codes of Practice

- › BS EN 50171:2001 – Standard published in August 2001 specifically for Central Supply Systems
- › This standard references others:
  - › BS 5266 Pt 1 1999 – Code of Practice For Emergency Lighting. (Now replaced by BS 5266 Pt 1 2016)
  - › BS 5266 Pt 7 1999 (EN 1838) – Emergency Lighting Applications
  - › BS 5266 Pt 8 2004 (BS EN 50172:2004) – Emergency Lighting Systems
  - › BS EN 60598-2-22:1999 – Emergency Lighting Luminaires

# Central Battery Systems and Emergency Lighting

## Compulsory lighting locations – points of emphasis

The positioning and selection of emergency lighting equipment is subject to the nature of the area to be protected, and should be identified during risk assessment.

This should cover specific hazards and highlight safety equipment and signs. This section provides outline guidance on each of the defined areas that require protection. Areas initially requiring cover for designing a scheme are shown below and are mandatory.

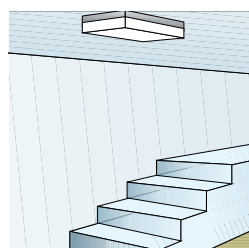

A - Each flight of stairs

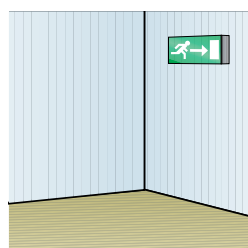

B - Change in direction along the escape route

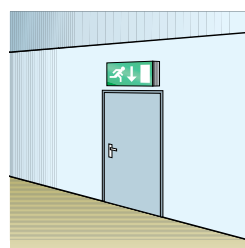

C - Exit doors

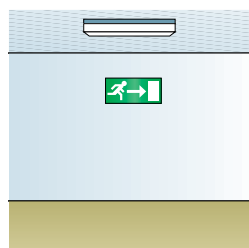

D - Safety signs

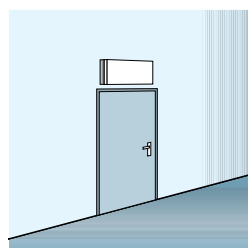

E - Each final exit point (internally and externally)

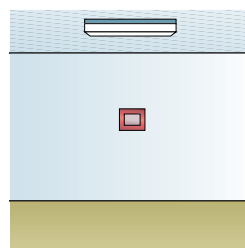

F - Fire alarm call points

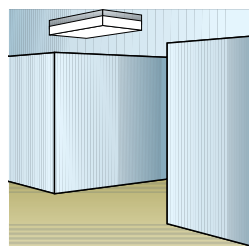

G - Each intersection

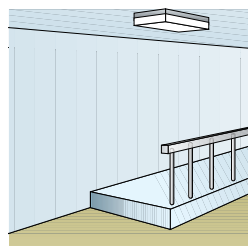

H - Change of floor level

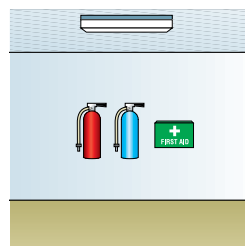

I - Fire fighting equipment / first aid points

## Additional emergency lighting should be provided for:

- › Lift cars
- › Toilet facilities and other tiled areas which exceed 8m<sup>2</sup> floor area and toilet facilities for the disabled
- › Escalators
- › Motor generator, control or plant rooms
- › Covered car parks along pedestrian routes
- › External escape routes

## Exit signage

These are required at all exits, emergency exits and along escape routes. A directional sign is required when sight of an emergency exit sign is not possible or doubt may exist. BS 5266 and EN 1838 state that all the emergency escape route signs and luminaires, which should be of the same design format, should be placed in all areas.

## Maximum viewing distance

Calculated using the following formulae:

- › 200 x H for internally illuminated signs
- › 100 x H for externally illuminated signs

## Escape Routes

After all mandatory Luminaires and Exit signs have been positioned, it may be necessary to provide additional luminaires so that a minimum light level is reached along the escape route. The luminaires on an escape route of up to 2m wide should be positioned centrally. The illuminance is specified along the centre line with 50% of that illuminance over the 1m wide central band. Wider routes are treated as Open Areas or as multiple routes.

In terms of illumination, EN 1838 calls for a minimum of 1.0 lux anywhere along the centre line of the

escape route. The UK has a National Exception which accepts 0.2 lux along the centre line as long as the escape route is permanently unobstructed with points of emphasis to 1 lux. Spacing tables provide assistance in these calculations.

BS 5266 recommends using a larger number of low power luminaires rather than a few high power units. In this way it ensures no part of the escape route is lit by just one luminaire.

Reference to the Photometric Data will provide you with the information needed to determine the number of additional fittings that are required, with the existing luminaires provided to illuminate points of emphasis.

## Anti-panic or open areas

Areas that are not escape routes or high-risk, but still within the general requirements of current legislation, are known as open areas.

The European Standard EN 1838 calls for a minimum of 0.5 lux measured at floor level anywhere within the area excluding shadowing effects of room contents. The core area also excludes a 0.5m perimeter.

## High-risk task areas

The European Standard EN 1838 requires that higher levels of emergency lighting are provided in areas that are considered to present danger to a building's occupants, in the event of a mains lighting failure, to be adequately illuminated.

Adequate illumination is defined as at least 10% of the normal lighting, with a minimum level of 15 lux and continues for as long as the hazard exists. The average horizontal illuminance on the reference plane (not necessarily the floor) should be as high as the risk demands.

# Central Battery Systems and Emergency Lighting

## Self-contained luminaires

The first is a system that utilises luminaires with their own battery, charger and changeover circuits. They also include conversion kits that can be used to enhance mains fluorescent luminaires, enabling them to provide illumination in the event of a normal supply failure.

### Benefits

- › Easy and quick to install
- › Minimal wiring costs
- › Reliable
- › Ideal for smaller installations
- › Safe – if one luminaire fails, the rest will still operate
- › Site expansion easily catered for
- › Widely available off-the-shelf

### Drawbacks

- › Batteries have a limited working life, and are susceptible to high ambient temperatures
- › Relatively expensive for larger installations

## Centrally-supplied systems

The second type of system is one that is linked to a remote back-up power supply, which provides energy in the event of a normal supply failure. Of these, there are two basic types:

### DC battery systems

These comprise of a battery, charging circuit and control circuit to provide DC power when needed.

### Benefits

- › Low running cost
- › Extended system life
- › Easy to test and maintain
- › Relatively low luminaire cost
- › Luminaires able to operate at high ambient temperatures

### Drawbacks

- › Requires separate fire resistant distribution wiring

## AC battery systems

These are central battery systems fitted with an inverter, to provide AC power in the event of a normal supply failure. Control circuitry is also incorporated to ensure a stabilised power output.

### Benefits

- › Low running cost
- › Extended system life
- › Easy to test and maintain
- › Relatively low luminaire cost
- › Luminaires able to operate at high ambient temperatures
- › Able to utilise existing mains luminaires
- › Potential for producing higher light output

### Drawbacks

- › Requires separate fire resistant distribution wiring

## Selecting a central system battery

The main points to consider when selecting a battery type are the required life of the installation and the pattern of investment required i.e. is a lower initial cost more important than the total cost over the life of the system, inclusive of maintenance? These considerations determine which battery may be most suitable.

### Battery types

#### Gas recombination lead acid

- › Maintenance limited to periodic voltage checks. No special battery room needed
- › Compact design – takes up less space than other battery types
- › Up to 10 year design life at 20°C
- › Low initial cost
- › Low voltage cut-off required, cannot be left discharged

#### Vented lead acid planté

- › Complies with BS 6290 Part 1 and 2 – Designed for 25 years life
- › Pure lead positive plate – provides full capacity throughout life
- › Clear containers – for visual inspection of electrolyte and plates
- › Relatively high cost – bulky and heavy, cannot be left discharged for prolonged periods, needs regular maintenance, ventilated battery room required

#### Vented nickel cadmium alkaline

- › Long design life – 25 years
- › Resistance to abuse and temperature variations
- › Highest initial cost of the three battery types, ventilated battery room needed, high maintenance costs, requires to be topped up

Battery	Initial cost	Design life	Maintenance
Sealed Recombination Lead Acid	••	••	••
Lead Acid Planté	••••	••••	••••
Vented Nickel Cadmium	•••••	•••••	•••••

• = Scale of Cost

# Central Battery Systems and Emergency Lighting

## Wiring, maintenance and testing considerations

### Cable sizing and voltage drop

As slave luminaires can be positioned a substantial distance from their power source (the central system) and since they must be wired in suitably protected cable, sizing must be carefully considered.

### Wiring requirements detailed in BS5266-1 2016

Cables used for central battery systems should be resistant to the effects of fire and mechanical damage. Cables should be routed through areas of low risk.

BS5266-1 2016 Clause 8.2.2 states one of the following:

- a. Cables with an inherently high resistance to attack by fire should, as a minimum, have a 60 minute survival when tested in accordance to BS EN 50200:2015 (Class PH60 in Annex D).

In addition, the cable should meet the 30 minute survival time in accordance with BS EN50200:2015 Annex E.

They should also conform to one of the following standards A) BS EN 60702-1 with terminals conforming to BSEN 60702-2, B) BS7629-1, or C) BS7846.

- b. Enhanced Cables with an inherently high resistance to attack by fire should, as a minimum, have a 120 minute survival when

tested in accordance to BS EN 50200:2015 (Class PH120 in Annex D).

In addition, the cable should meet the 120 minute survival time in accordance with BS 8434-2.

They should also conform to one of the following standards: A) BS EN 60702-1 with terminals conforming to BSEN 60702-2, B) BS7629-1, or C) BS7846.

- c. Cable System with an inherently high resistance to attack by fire comprising fire resistant single-core or multi-core enclosed in steel conduit such that the cable has a 60 minute survival time. Cable should meet the requirements of IEC 60331-3. Single-core cables should comply with BS8592.
- d. Cable System with an inherently high resistance to attack by fire comprising fire resistant single-core or multi-core enclosed in steel conduit such that the cable has a 120 minute survival time. Cable should meet the requirements of IEC 60331-3. Single-core cables should comply with BS8592.

### BS5266-1 2016 clause 8.2.5 conduit

If an emergency lighting cable is to be run in conduit in order to provide additional mechanical protection, the material of the conduit may be either metallic or non-metallic providing it is of adequate strength. Non- flame propagating trunking conforming to BS4678-4 may be used. Where cables are run in conduit or rigid PVC, it should conform to relevant part of BS EN 61386.

## BS5266-1 2016 clause 8.2.6 segregation

The wiring of the emergency lighting should be exclusive to the installation and separate from the wiring of any other circuit.

### Cable Sizes

Cables of less than 1.5mm<sup>2</sup> should not be used. The volt drop of the connecting the central battery system should not exceed 4% of the system nominal voltage at maximum rated current.

Cables of less than 1.5mm<sup>2</sup> should not be used. By applying the values for a particular system the correct cable size can be chosen: Volt drop = 1V, 2V, 4.5V, for 24V, 50V for 110V systems.

Select a cable such that the value is equal to or less than the calculated value and the selected cable's current rating exceeds the load current. If a suitable cable size is not identified, alternative ways of overcoming excessive voltage drop should be considered:

1. Increase the system voltage to 50V or 110V. If 110V DC system is impractical, a 240V AC sinewave inverter system may be considered.
2. Increase the number of distribution circuits.
3. Reduce cable runs, e.g. consider separate central systems to cover different parts of a building.
4. Use cable grading from the central system to luminaires.
5. Use 'ring' type wiring circuits.

## Maintenance and testing

The tasks of regular maintenance and testing are vital to make sure that a systems integrity and capacity to fulfil its task are maintained at all times.

BS 5266 Part 8: 2004 Clause 7 details Servicing and Testing.

Honeywell Services can offer a comprehensive range of testing and maintenance solutions.



# Eliminating Nuisance Alarms

In 2010-11, over half of all fire-related incidents attended (i.e. all fires plus false alarms) were false alarms. Malicious false alarms accounted for just 2% of all fire-related incidents, whereas false alarms due to apparatus accounted for just over a third of all fire-related incidents\*.

Nuisance alarms cause disruption, inconvenience and ultimately cost money through lost time and the threat of delayed response or charges from the Fire and Rescue services. It is therefore essential to minimise the likelihood of nuisance alarms from automatic fire alarm systems.

Correct installation, service and maintenance practices play a key role. Of equal importance, however, is skilled system design tailored for each individual building's requirements and utilising the latest advances in fire detection and alarm systems. This section takes a look at each of these elements in turn.

## Legislation and Codes of Practice

- Reference should be made to BS 5839-1:2017 sections 34 and 35 which focus on the limitation of false alarms
- Regulatory Reform Order – Fire Safety 2006

# Finding a Competent Supplier

## Selecting a competent company

It is important that a new system is commissioned by a competent person who has attended recognised training courses on the equipment as well as the British Standard. Good system design and appropriate selection of detection technologies can have a significant effect on the occurrence of nuisance alarms. However, without correct servicing and maintenance over time a system will become more prone to giving false evacuation signals.

It is the duty of the 'responsible person' of the building under the RRO to ensure that competent people are employed to install, commission and maintain their fire system. Selecting a 3rd party accredited (BAFE or LPS1014) company is the easiest and most reliable way of doing this.

## Freedom of choice and peace of mind

The relationship between the 'responsible person' and the service provider is a key one – therefore, it is essential to get this right.

When it comes to choosing a company to install and maintain your Notifier system, you can be confident of complete freedom of choice, from a network of over 60 independent fire installation, commissioning and maintenance companies. Every one of them has completed a comprehensive training programme and has direct access to extensive product, technical and application support. As a result, you know you are working with a competent company with the expertise necessary to ensure the highest standards of fire safety.

## Fire system protocols – your questions answered

*"My fire alarm system works fine but I'm locked into a contract for service and maintenance, and the prices go up every year."*

Throughout the lifecycle of a Notifier system, you choose who installs and maintains your fire alarm system. In the UK and Ireland, there are more than 60 independent, competing Notifier-approved engineered systems distributors (ESDs), ensuring best value through competition. Closely supported by Notifier, they are fully trained and have the tools required to install, commission, maintain and service Notifier systems to the very highest levels.

*"I've been told I need a new smoke detector. The detector is no longer available from the manufacturer, so I need a whole new system fitted!"*

This won't happen with Notifier – we're 100% committed to backward compatibility, so a detector bought today will continue to work on a Notifier system installed 15 years ago. And, all parts of a Notifier fire system are specifically designed to work together, giving exceptional system functionality and reliability as standard.

*"My fire risk assessment states that I am responsible for selecting a competent person to service and maintain my fire system. How do I know who's 'competent'?"*

Whichever Notifier ESD you choose to maintain, your Notifier system will be competent, have the skill and experience necessary to carry out the work and ensure you meet your obligations under the Regulatory Reform (Fire Safety) Order Act.

How do we know this? Well, all our ESD partners are independent fire specialists who have completed full factory training on our products and the majority have achieved independent accreditation. So, you are assured of quality, reliability and value for money throughout the life of the system.

*"I've been advised that I should have an open protocol system installed. What does this mean?"*

The term 'protocol' refers to the language a fire alarm system uses to communicate between the control panel and the various detectors, call points and modules which make up the system. All fire detection and alarm systems currently available, once installed, are locked to a specific protocol to ensure they work correctly.

*"...but what does this really mean to what's important to me – protecting my business and complying with the regulations without it costing me a fortune?"*

The implications of which protocol your fire system uses can be very restrictive, sometimes meaning you are tied to only one company to service, maintain and supply spare parts for your system. In this case the system can be termed 'closed protocol'.

# Service and Maintenance

## Regular maintenance

Anyone can maintain any fire system; however, it is strongly recommended and backed up by the CFOA policy for signalling to a central station, fire systems should be maintained by BAFE SP203 or LPS1014 accredited companies.

Over time, the sensitivity of a smoke detector can change owing to a build-up of dirt in the detector chamber. In most modern detectors this effect is slowed by the inclusion of drift compensation functions, however the build-up can still lead to a risk of false alarms or change in the detector sensitivity.

The frequency of maintenance requirements on a detector will depend on site conditions; obviously the dirtier the site the more frequent maintenance will be required. The optimum frequency for a given site should be determined over a period of time after the commissioning of the fire system.

All Notifier detectors (smoke, heat, or multi-criteria) are designed such that they can be easily dismantled for maintenance. Instructions are given for maintenance in the instruction manual supplied with each detector. Normally it is sufficient to use compressed air or a vacuum cleaner to remove dust from the detector chamber.

Once maintenance on a fire detection system has been completed, it should be re-tested.

## Routine functional testing

BS 5839-1:2017 gives a range of recommendations regarding routine testing of a fire detection system.

A weekly test should be carried out on a fire detection system by activating a Manual Call Point to ensure that all fire alarm signals operate correctly, and that the appropriate alarm signals are clearly received. This test should be carried out at approximately the same time each week, using a different call point in rotation.

In order to comply with BS 5839-1:2017, periodic inspections, servicing and functional tests of the fire alarm system should be carried out at intervals determined by an assessment of the site and type of system installed, not normally greater than six months.

It is recommended to perform regular functional tests on all fire detectors annually. These annual tests may be carried out over the course of two or more service visits during the twelve-month period.

Notifier detectors include various means of testing the system without using smoke, dependent on the detector range being tested, including magnet switches and laser test tools.

Codes and Standards (in the UK BS 5839-1:2017, Section 6) now require functional tests to introduce smoke through the smoke detector vents and into the sensing chamber. It also calls for heat detectors to be tested by means of a suitable heat source, and not by a live flame.

CO fire detectors now also need to be functionally tested by a method that confirms that carbon monoxide can enter the chamber.

Many installers use a set of equipment that consists of a complete range of test tools that locate on the end of the pole in order to aid compliance with codes. Tools exist for testing smoke, heat, and CO fire detectors, whilst also enabling them to be accessed and removed at heights up to 9 meters from the ground.

Using functional test equipment, along with those maintenance tools available from Notifier, should ensure that the system remains at its optimum operation for many years.

# Advanced Alarm Management

Modern fire systems have become more and more capable, not only in terms of early warning of a fire threat and avoidance of false alarms, but also in their ability to be programmed to meet some very specific requirements of a wide variety of buildings.

The safety and efficiency benefits of advanced system monitoring, either centrally or from a remote location, are also becoming more widely understood.

This section takes a look at some of the advanced functionality available to system designers and provides some examples to illustrate the value these functions bring in the real world.



# Configuration and Connectivity

## Multiple device dependency

Perhaps the best known is the use of multiple events to confirm that a fire is real before evacuating a premises or shutting down a critical process. The simplest form of this is for the system to give only a warning on the first activation, proceeding to carry out automated Cause & Effect if a second alarm is signalled by detection devices.

There are many refinements possible; maybe the devices must be of different technology, the system may either reset or proceed to full alarm if no action is taken after a certain time.

Some systems also allow for automatic reset if no confirmation signal is received, so that the system is fully automated and does not need to be managed full-time.

The common factor is that the reason for these types of dependency is to prevent a business from losing time due to an unnecessary evacuation or shut-down while still ensuring that people and the property are properly protected.

## Single multi-criteria device dependency

Multi-criteria devices incorporate more than one sensing technology and can be used to confirm alarms in a similar way to the use of multiple devices of different types.

## Time delay

An alternative to multiple detection dependency on a manned site is to provide a system of time delay; an initial signal is given to staff on site, typically they have a short time in

which to acknowledge the signal and to begin investigation. The acknowledgement extends the delay to a time not exceeding ten minutes from the original alarm (according to EN 54-2) after which the configured outputs are switched on if the alarm has not been reset.

This system relies on a manual intervention to confirm the alarm rather than the confirmation being automated although such a system is often combined with a multiple detector dependency so that if two devices signal alarm the delay is overridden and the Cause & Effect program is implemented.

It is also common to change the strategy depending on building occupancy; for example the delays might be overridden at night when the building is empty. It is also common to change the sensitivity of detection – in some cases even disabling smoke detection – during the day.

## Time dependent system programming

A sensor may be allocated to one of two user-configurable Time-of-Day (ToD) programs. This function is very useful when, to avoid false alarms, the sensitivity of devices can be changed during preset periods of the day, e.g. mornings and/or afternoons, and for different parts of the week, e.g. week days and weekends.

Cause & Effect (C&E) rules can also be linked to a ToD program. However, a ToD program, when active, is normally used to change sensor sensitivity. It is possible to set different amounts of sensitivity change to allow for the sensing characteristics of different device types.

## Staged evacuation

Whilst dependencies are used to prevent unnecessary business down-time there is also the concept of staged evacuation.

This means a system that does not require an entire building to be evacuated in the case of a single alarm. The evacuation is restricted to a single fire compartment, extending to the adjacent area only if the fire spreads across the fire barrier.

This is often confused with phased evacuation but the two are fundamentally different; phased evacuation is used to control the evacuation of entire premises so that it may be carried out safely and speedily, for example, in a tower block with limited capacity on the escape stairwells.

In the case of phased evacuation, the various areas (building floors, in the example), are evacuated in a set sequence at predetermined time intervals. Of course, the sequence is started in the area where fire is detected, which is not always from the same place.

Today's fire detection and alarm systems are capable of being configured to very specific requirements including interfacing with or controlling smoke dampers and fans to ensure safe exit is available.

It is very common to see various plant shut-downs carried out at different times after detection of a fire.

The Cause & Effect strategy overlaps the detection strategy to contribute to the earliest detection and indication of an event so that it can be dealt with while still minor and the control of evacuation and shut-down so that the risk to assets can be minimised while recognising the cost of unplanned process shutdown.

The fire system is fully capable of being adapted to meet the exact recommendations of the risk assessment and can vary in different areas of the building.

# Configuration & Connectivity

## Example: Utilising Type B Dependency Two Stage Alarm from a Single Multi-criteria Device

A particularly challenging example of the use of dependencies is to integrate the requirements of a building which contains both shared areas and individual sleeping accommodation such as warden assisted flats. Within this example, the shared areas require a fire system compliant with BS 5839-1:2017, whilst the individual flats require systems compliant with BS 5839 Part 6 2019.

Traditionally, these sorts of installation have been provided with individual systems for the flats linked to a landlord system for the shared area.

Type B dependency allows a zone to be defined for each individual flat that acts as if it were a separate system. On receipt of an unconfirmed fire signal from a flat only the local alarm within the flat is given. If the alarm is confirmed by a second signal

the system proceeds to the relevant evacuation stage (general alarm or part of staged evacuation). Alternatively, if the confirmation signal is not given the system may reset automatically without attendance by the warden.

In this case, a confirmation signal may be given by; a second device in the same zone, a second signal from the same device (either after a certain time or from a different sensor within a multi-criteria detector), or a manual confirmation e.g. from a call point.

This scenario enables a single integrated system to be used whilst avoiding the possibility of unnecessary disruption to other residents due to nuisance alarm signals (such as burning toast). It also eliminates the need for the system to be manually reset once the nuisance smoke has cleared.

By using an input relay module, a signal can be transmitted via a call system to the warden of an unconfirmed alarm enabling them to investigate.

Confirmed alarm given if smoke persists for a pre-defined length of time

Confirmed alarm received from if device in escape route activated



Confirmed alarm given from second signal from multi-criteria device, e.g. smoke and heat

Confirmed alarm given if second device in same zone is activated

# Configuration and Connectivity

## Example: Utilising type b dependency And local silence button

Extending the features of Type B Dependency by now incorporating a Local Silence facility further enhances the most effective false alarm solution in the market.

The Type B Dependency features and the Local Silence Button gives the system user further control over the system in a safe and controlled manner.

The user is able to silence the local sounder or sounder beacons within their premises by pressing the "Fire Alarm Silence" button when they have activated a Type B smoke detector within their premises. When the site is in a full evacuation mode this feature is disabled and the local sounder or sounder beacons cannot be silenced by the user.

If the user believes that they may generate an unwanted alarm from a smoke detector within their premises due to excessive amounts of smoke or dust being produced; the user can press and hold the "Fire Alarm Silence" button for a 5 second period or until the yellow LED illuminates which will then disable the detection in that zone only for a configurable period of between 5-15 minutes in accordance with BS5839 Part 6 2019.

This period is configured by the installer at time of commissioning and in agreement with all interested parties. At the end of the configured period the zone will automatically re-enable, all detection will be active and the LED will be extinguished.

A test feature is available, which allows the user to operate the sounder or sounder beacons within the local zone by pressing and holding down the "Fire Alarm Test" button; once released the sounder or sounder beacons will silence.



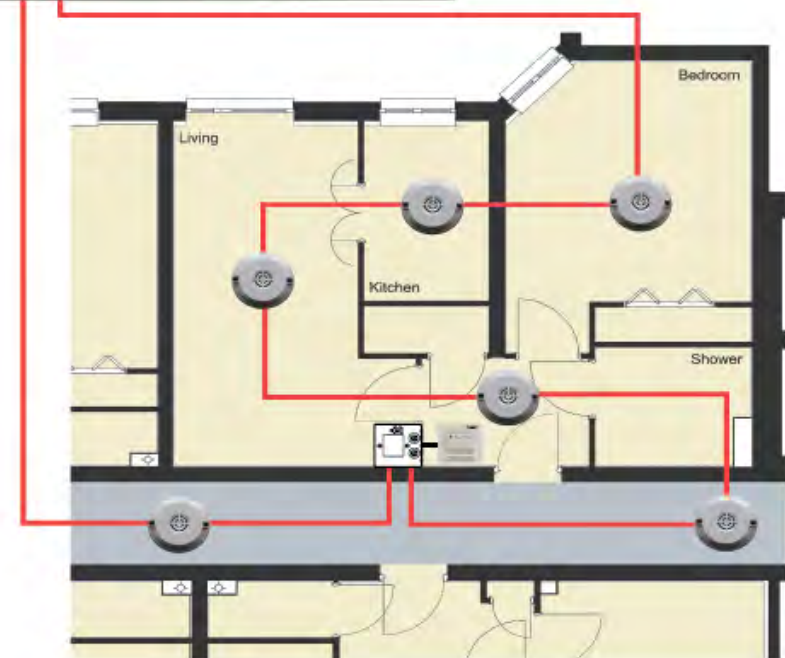

The button is connected to the Pearl Loop via a Notifier M721 dual input/ single output interface unit and a 5 core cable — supplied in the kit.

As this button is supplementary to the main system and not part of the Critical Signal Path, we would not expect this to be wired in fire rated cabling, however this is at the discretion of the installing company and end user.



## Product range at a glance

	Part Number
 Notifier Local Silence Button Kit – Includes Interface, int enclosure and wiring loom.	NF-SIL-BKIT
 Notifier Local Silence Button Assy Notifier Local Silence Button Assembly – includes wiring loom.	NF-SIL-B

# Configuration and Connectivity

## Cause & Effect programming

Fundamentally, the intention of C&E programming is to derive a clear set of rules, or logic statements intended to establish the behaviour of output devices in response to a change of state of one or more input conditions.

A rule can only be configured to perform one task, although a number of rules can be combined to provide solutions for more complex C&E Programming (using logic-statement links called Flags).

A rule comprises two distinct action statements:

**Input statement** – this part of the rule is a qualifying input condition, such as a fire or fault, or the detection of a change in state of a specific input category, e.g. zone coincidence rule conditions satisfied, an input from an external device, etc.

**Output statement** – this part of the rule can only be processed when all the programmed input conditions are met. The output is concerned with the operation of one or more assigned devices, such as sounders or relays, or the change of state of an output condition, using a logic flag, used to implement a secondary-stage action, which requires a number of qualifying input statements to be satisfied.

Avoid conflicting logic when programming C&E rules. It is vitally important that any configured rules are tested rigorously during system commissioning to establish that there are no rule logic conflicts.

## Working example of C&E rules

This section is intended to illustrate C&E programming using a typical working example.

### Simple C&E programming

“How do I create a rule to allow staged evacuation in the event of an alarm in a specified zone?”

This is very straightforward to do and we will use a multi-storey building to explain how this may be accomplished.

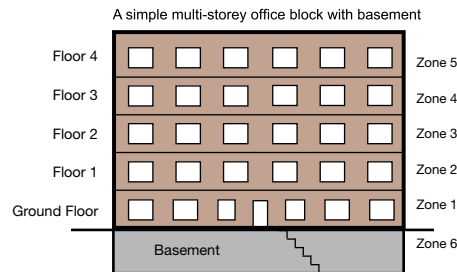

There is more than one way to achieve this. However, we will consider the easiest method first. This requires a number of rules to be created, each comprising input, and output statements.

The configuration of a set of C&E rules (matrix) of a single control panel is only discussed here.

**Rule 1** Says that for any alarm input, all sounders for each zone are to activate in pulsing mode (the alert pattern).

**Rule 2** As a steady sounder output overrides a pulsing output, a rule must then be created for each zone so that an alarm in that zone activates the sounders for that zone in steady mode.

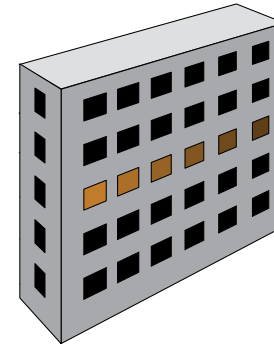

A fire is detected in Zone 3. Immediately, all C&E matrix rules are examined for output actions against input conditions.

**Note:** Any active ToD programs are also taken into account.

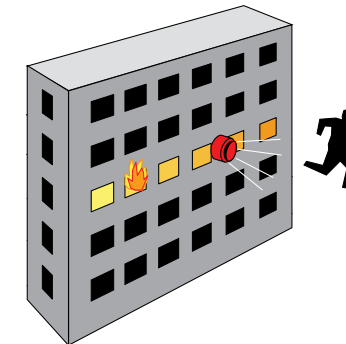

Two of the configured C&E rules are satisfied:

- An alarm in ANY zone operates sounders in ALL zones in pulsing mode.
- An alarm in Zone 3 operates sounders in Zone 3 in steady mode.

For the example illustrated here, an alarm has been detected in Zone 3 (floor 2). The C&E matrix is immediately examined and all configured rules are processed for activation of the outputs. In this example, we are interested in any configured rules concerning an alarm condition being detected in Zone 3.

A number of rules have been configured to process alarms from any of the six fire zones for this building comprising five floors above ground and a basement level.

The first C&E rule is a general statement designed to operate sounders in all zones, in an alert mode, when an alarm is detected in any zone, as follows:

- › An alarm in ANY Zone activates the sounders in ALL Zones, in pulsing mode.

As a steady output overrules a pulsing output, a separate rule is created for each zone as follows:

- › An alarm in Zone ‘n’ activates sounders in Zone ‘n’ in steady mode.

However, there may be a requirement that the floor raising the alarm and the one immediately above must have its sounders operating in steady mode. For the floor above, a short delay is used to allow the fire zone to evacuate safely first. So, a rule has to be created for each zone immediately above to impose a delay before the operation of its sounders change from pulsing to steady. So, if this is the case, additional rules have to be created for each zone to operate the sounders in steady mode in the zone above it.

# Configuration and Connectivity



## Graphics systems

As businesses and facilities expand, so must the fire and life safety systems that protect them. The flexibility to properly monitor and control complex sites, centrally monitor a number of geographically dispersed sites or monitor a single site from different locations offers many benefits.

Modern fire system GUI (Graphical User Interfaces) enable total control over a fire and life safety system, allowing the operator to view and manage multiple local device networks and remote sites providing the right information to the right person wherever they are located.

Integrating fire systems using GUI systems can deliver greater safety and security whilst improving efficiency of maintenance operations and ensuring the integrity of data and audit trails.

The siting of GUIs has traditionally been constrained by the distance of industrial serial communication requiring them to be located near to the Fire Alarm Control Panel. However, the ever-increasing use of IP technology in the built environment adds flexibility to the location of the GUI by divorcing this link. Modern installations now have the flexibility to cope with the demands of potentially unforeseen change of use in any area of the building without incurring considerable inconvenience and cost of relocating expensive systems.

## Large scale or campus sites

The sheer scale of some sites present distinct challenges in ensuring both early warning of, and rapid, controlled response to a fire-related incident. The use of a GUI provides the ability to monitor such a site from a central location and pin-point events more quickly.

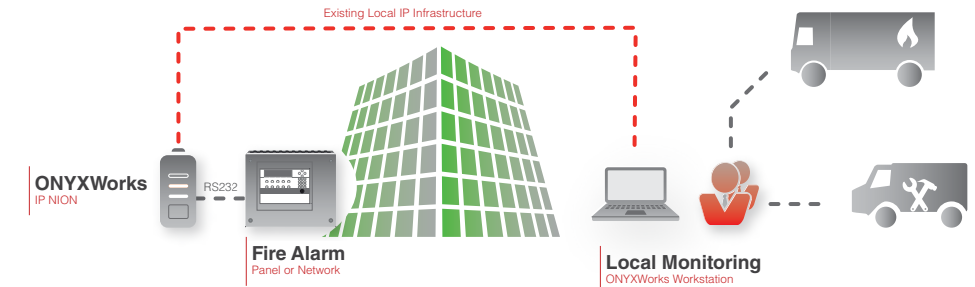

## Site monitoring from multiple locations

Remote monitoring of a fire system can provide benefits both in terms of emergency response and service and maintenance. Sites can be monitored from one location for emergency purposes and from a separate location by those responsible for service and maintenance.

- › Faster response to fire related incidents
- › Efficiencies in maintenance operations
- › Simplification of system control
- › Improved data management and audit trail
- › Monitoring the fire system from anywhere, internal or external to the building

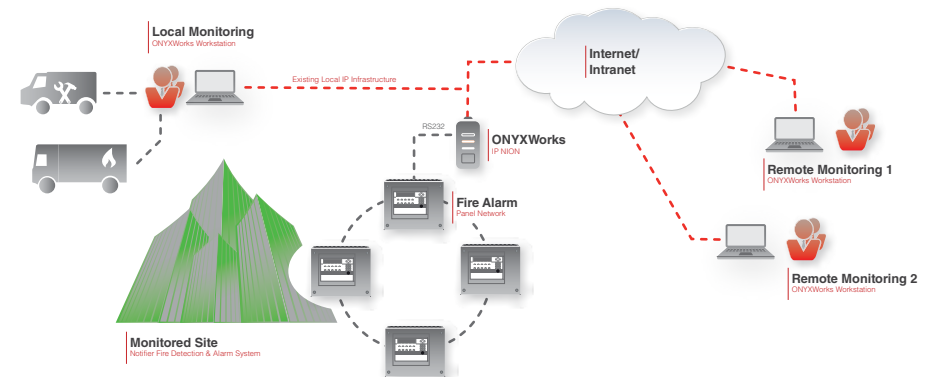

# Configuration and Connectivity

## Central monitoring of remote locations

### Large enterprises

If an organisation has multiple facilities across a campus, throughout a city, across the country, or around the world, central monitoring of these dispersed sites can be achieved using a remotely connected GUI.

- › Monitoring and record keeping – central control (and monitoring) of service and maintenance contractors
- › Remote monitoring of sites in isolated locations e.g. wind farms
- › Treat multiple remote sites like they are a networked campus site





## Service and maintenance providers

Providers of service and maintenance can install interfaces on the sites they manage, which enables them to monitor each site from their offices. This allows them to provide enhanced levels of service to their customers whilst providing important information which can be used to reduce the costs of travel to, and time on, the customer's site.

Proactive response to system faults

- › Reduced travel to diagnose system faults
- › Centralisation of workflow – less time required on site
- › Robust data management for record keeping and audit trail

## Product range at a glance

	Part Number
	ONYXWorks Fire Graphics Complete PC. Includes PC, Mouse, Keyboard. Windows 7 and ONYXWorks IP Software Pre-Installed. No Monitor included. <b>ONYX-CTRL-PC</b>
	ONYXWorks Fire Graphics software only, requires Windows 7 64 bit Pro PC. <b>ONYX-CTRL-SW</b>
	IP Gateway (NION), for connection to Notifier fire panel. Requires dc power and enclosure <b>ONYX-IP-NION</b>
	Multi-Mount Enclosure. Metal, Notifier Black/Grey. The enclosure is capable of housing: one ONYX-IP-NION. <b>002-439</b>

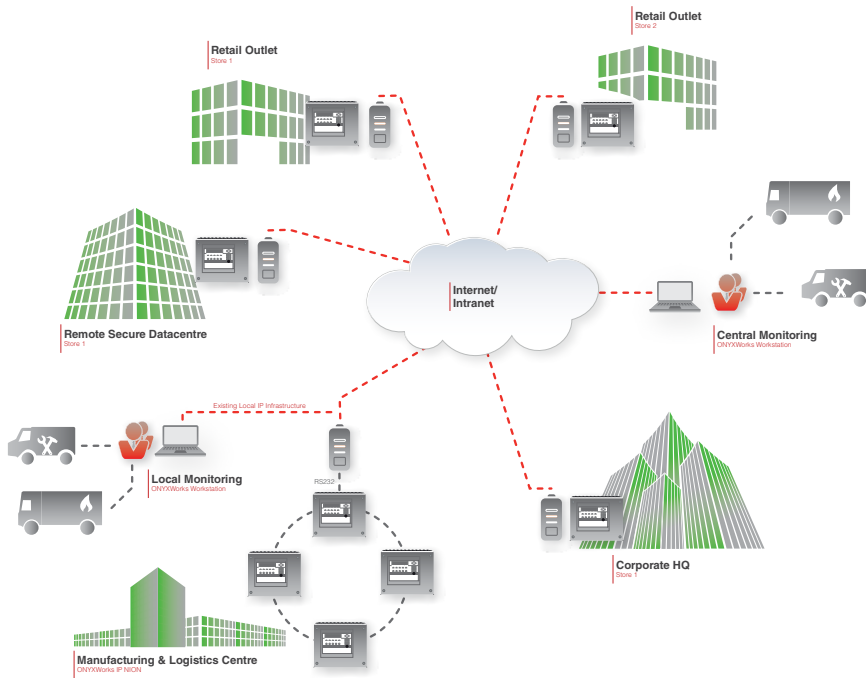



# Continuing Professional Development (CPD) Programme

Finding time to keep up-to-date with the latest changes and developments in the fire safety industry can be challenging. In today's business environment it has become more important than ever to stay at the cutting edge.

NOTIFIER by Honeywell has developed a series of Continuing Professional Development accredited seminars addressing some of today's key topics in fire safety. These complimentary seminars can be arranged at a time and place to suit you.

### CPD at your offices

As time is precious, seminars can be held at your offices, and timings can be tailored to suit your needs

### Supporting materials

Attendees are provided with full supporting documentation and certificates of attendance will be awarded on completion of the seminar

### Certified Courses

All CPD seminars have been officially certified by the Construction CPD Certification Service



#### Cloud Not Clipboard

The presentation is a guide to the increasing move to cloud-based connected tools being deployed and used in the fire industry. We focus on the increasing global move to connected devices and the 'Internet of Connected Things' and how this is impacting the fire industry, with a focus on best practice and guide to users on the importance of cyber security, system connectivity and compliance reporting.

1 HOUR



#### Taming the Li-ion - Designers' Guide to Lithium Ion Battery Off-Gas Detection

This presentation details the risks associated with the growing use of Lithium Ion battery technology and how best to detect the threat to life and property.

1 HOUR



#### An Overview Of Bs7273 Part 4 Actuation Of Release Mechanisms For Doors

This presentation details the recommendations in BS7273-4:2015, in respect to the monitoring and actuation of door release mechanisms controlled by a Fire alarm system. Guidance will be provided for Designers, Installers, Service providers and Manufacturers who need to ensure their products can provide the functionality recommended.

1 HOUR



#### Understanding The Cost Of Fire

This presentation looks at the case study of a fatal fire incident that took place at the RosePark care home in Lanarkshire on 31st January 2004. It provides an overview of the findings of a fatal accident enquiry and is designed to highlight some of the potential risks presented by buildings of this type and what can be done to mitigate those risks in order to help prevent future incidents of this type.

1 HOUR

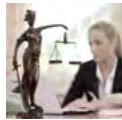

#### Understanding Fire Legislation

This presentation reviews the current legislation paying particular attention to The Fire & Rescue Services Act 2004 and the Regulatory Reform (Fire Safety) Order implemented in October 2006. As most of the new legislation is based on a risk assessment rather than a prescriptive approach, this seminar includes a guideline on what a fire risk assessment entails and what government help is available in meeting this new requirement.

1 HOUR



#### An Overview Of British Standard 5839 Pt 1

This presentation is an overview of the revised British standard BS 5839-1: 2017, which is the Code of Practice for system design, installation, commissioning and maintenance of fire detection and alarm systems within the UK and Northern Ireland. It is aimed at advising any professional party involved in providing a system, with advice on what is required in each step of the process, as well as explaining to the end-user and their service provider what their ongoing responsibilities are during the life of the system.

1.5 HOURS



#### Detector Selection And False Alarm Prevention

This presentation contains guidelines for improving alarm system design. It shows how it is possible to strike a balance between detecting real fires quickly whilst minimising the risk of false alarms. This is not a new issue but has become more sensitive in light of new legislation which has seen Fire Authorities reducing the level of response depending upon the number of false alarms from individual sites.

1 HOUR



#### A Guide To Service And Maintenance

This CPD reminds all building owners and occupiers why it is important, under current legislation, that your building's fire detection system is properly maintained. It reviews the responsibilities of the owner / occupier and of the service provider towards protecting employees, visitors, property and importantly, your business.

1 HOUR



#### Guide to HTM 05-03

Learn about how the requirements for fire detection systems within NHS healthcare premises are affected by the current Legislation, the British Standards, and the NHS Firecode HTM 05-03.

1.5 HOURS



#### Fire System Protocol – What Does It Really Mean?

The issue with system protocol in the fire industry is that the terms "open" or "closed" are used in so many different ways. This confusion often results in the real issues being overlooked. If you asked 10 people for their definition of what Open or Closed protocol fire systems actually are, the chances are you would find that everyone had a different version of what they understand the term to mean. This presentation looks at what protocol really means and then identify what is really important when choosing which fire system to invest in.

1 HOUR



#### Optimising Early Stage Smoke Detection

To provide a clear understanding of how early stage smoke detection can be optimised through advanced aspiration technology and 3D design tools. The presentation explains how new aerospace inspired technologies and advanced solution design can deliver enhanced, EN54-20 compliant early stage smoke detection in challenging environments with exceptional levels of accuracy and reliability.

1 HOUR



#### An Alternative to Aspiration

Protecting business critical equipment. The seminar discusses a number of solutions to issues faced in the use of high sensitivity smoke detectors for critical applications such as EDP areas, Internet data centres, Network operating centres and areas that typically have an increased fire risk due to high power requirement and density of equipment.

1 HOUR

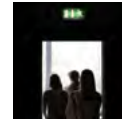

#### An Overview of Emergency Voice Communication Systems (EVCS)

This seminar explains in detail the requirements governing when and how an Emergency Voice Communications System should be provided. It is designed to increase the understanding of those involved in supplying a system as to what is required in each step of the process, including the guidance provided within British standard BS 5839-9: 2021.

1 HOUR



#### Demystifying the Design And Use Of Voice Alarm/PA Systems

This presentation gives an awareness of the requirements of the British Standard BS 5839 Part 8: 2017 to someone who is new to the task of providing a Voice Alarm system. It provides some background research and explains the benefit of having voice alarm messages, as opposed to simple alarm sounders. It will also provide some advice on what to consider when designing a system, identifying some of the problems and their solutions especially with regard to audibility and intelligibility.

1.5 HOURS



#### A Designer's Guide to Fire Alarm Systems

This CPD is a designer's guide for fire alarm systems, covered within British Standard BS5839-1: 2017: Section 2 which is the Code of Practice for the design of fire detection and alarm systems within the UK and Northern Ireland. It is aimed at providing any professional party involved in the designing of a fire alarm system with guidance on the choice and positioning of fire alarm equipment within a building.

5 HOURS



#### A Guide to Wireless Fire Alarm Systems

This presentation looks at how Wireless Fire Alarm equipment is used where cabling is not suitable or aesthetics is a key concern. This presentation takes you through the fundamentals of radio in fire alarm systems, various technology types and methods of planning, surveying, commissioning and maintenance along with methods of recording this information which is required for compliance to BS5839-1:2017

1 HOUR

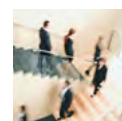

#### Bs8629:2019 Emergency Evacuation Alert Systems

This presentation details the recommendations in BS8629:2019, in respect to Emergency Evacuation Alert Systems. Guidance will be provided for Designers, Installers, Service providers and Manufacturers who need to ensure their products and services can provide the functionality as recommended.

1 HOUR



#### Central Battery Systems Application and Design of Central Power Supply Systems

This seminar is a guide providing information on designing emergency lighting central power supply systems, and explains the advantages and disadvantages of different types of batteries along with AC sine wave inverters and DC Systems. The CPD also provides information on the components, wiring and testing requirements that should be carried out in accordance to BSEN50171:2001.

1 HOUR



# Detector Selection Quick Guide

Suppressing false alarms without losing early indication of a real fire is all about choosing the right detector for the right application.

The preceding sections of this guide have looked at these in some depth. This section is designed to provide a quick step-by-step process for selecting the right detection technology to protect a specific location.

Simply follow the process outlined in this section with reference to the two tables covering false alarm risk and General Applications.

# Detector Selection

## Step 1.

### Consider the sort of fire that is likely to occur

Fires differ enormously and ensuring the earliest detection for the broadest range of likely or possible fires can be a challenge.

One solution to the problem is to use a detector with more than one sensing element that can be used in a wider range of applications as they combine sensing of different products of combustion to confirm alarm. However, there is no 'one size fits all' detector and good knowledge of the potential fire risk is essential in order to ensure the fastest detection of a real fire.



## Step 2.

### Identify potential sources of nuisance alarm

The ambient conditions in a building can fool some detectors into signalling a fire when there isn't one, so it is important to identify possible causes of false alarms to avoid unnecessary, inconvenient and costly evacuations.

Notifier's comprehensive range of detection technologies gives you the tools you need to 'design-out' nuisance alarms and all but eliminate the frustration caused by unnecessary evacuations.

Consider using confirmation delay if earliest detection is to be balanced against greater false alarm risk.



## Step 3.

### Quick selection tool

To help make the right choice of detector we have created a quick selection tool.

Simply select the specific risk of false alarm or the general application from the tables on the following pages. These tables provide recommendations for detector type to be used in specific circumstances. The selections are based on a balance between early detection and false alarm rejection. An appropriate sensitivity and potentially confirmation delay should be configured according to the individual situation.

Sensitivity may be programmed to change according to time of day and reference can be made to the 'Advanced System Configuration and Connectivity' chapter in this book. In some cases parts of a multi-criteria detector may be prevented from giving an alarm at all, for example, giving only heat detection. It's important to remember that if contaminants are present, detectors will need to be cleaned regularly.

This table is designed as a guide for the most suitable detector, however, each installation is different and conditions may vary. If you require guidance on specific projects please contact your Notifier Business Manager.

# Detector Selection – False Alarm Risk

Cause of false alarm	Recommendation	Reason
Aerosol (excessive)/chemicals	Aspirating system	Air may be filtered before detection. Also means electronics are not in an aggressive environment.
Aerosol (general)	Aspirating system	If aerosol presence is intermittent SMART <sup>3</sup> could be used.
Burning toast/food	Heat or SMART <sup>3</sup>	A delay is necessary to allow smoke to clear the detector. This is a real fire.
Cigarette smoke (excessive)	SMART <sup>3</sup> / SMART <sup>4</sup> scenarios	A short delay is generally sufficient. SMART <sup>3</sup> means that detection is not compromised.
Cooking fumes	SMART <sup>3</sup> or heat	Delays optical response for a short time while the fumes clear. Clean detectors regularly.
Direct sunlight	SMART <sup>3</sup> or SMART <sup>4</sup>	If the sunlight leads to a thermal barrier then consider low level supplementary detection, e.g. via ASD.
Dry ice	SMART <sup>4</sup> (scenario 4)	This is specifically designed into the detectors intelligence.
Dust (temporary e.g. builders' clear up period)	Fit dust covers to sensors	Detector must be kept clean. Consider temporary change to heat detectors.
Dust or lint (excessive)	SMART <sup>3</sup> or SMART <sup>4</sup>	In extreme cases use ASD with filters.
Fork lift trucks and cranes	SMART <sup>4</sup> or beam	Use a delay if the beam gets interrupted.
Heating – gas (clean burning)	SMART <sup>2</sup>	If the chimney is not effective then there is a false alarm risk.
Heating – wood, coal, coke or flame-effect gas	SMART <sup>4</sup>	If the chimney is not effective then there is a false alarm risk.
Fumes from hot oil based machines (suds etc.)	SMART <sup>3</sup> or SMART <sup>4</sup> ASD with filter	Optical alone is likely to give false alarm. Frequent cleaning is important.
Gas (e.g. battery charging)	VIEW or Aspirating system	If the environment is very aggressive use ASD with filters.
High humidity (up to 95% RH)	Aspirating system	Use water trap to overcome condensation.
High-powered electromagnetic equipment	Aspirating system	Using ASD allows electronics to be away from interference.
Insects and harvest flies or small spiders/mites	SMART <sup>3</sup> or SMART <sup>4</sup>	If the detector becomes infested then these may be a false alarm. The SMART detector prevents alarm from transients.
Low humidity (less than 15% RH)	Avoid any detector with CO cell	Dry environments cause CO cell to age faster.
Rapid air changes	Aspirating system	Consider using VIEW. Optical will not respond in high airflow.
Soldering	SMART <sup>2</sup> or SMART <sup>3</sup>	SMART devices will suppress occasional smoke/fume. It is assumed that fume extraction will remove most of the fumes.
Steam or water vapour (excessive/constant)	Aspirating system	If point detectors are used they may corrode in a warm, damp environment.
Steam or water vapour (occasional/light)	SMART <sup>3</sup> or SMART <sup>4</sup>	Occasional steam will be rejected
Temperature – high ambient	SMART <sup>3</sup> or TFIX78	If high ambient temperature leads to stratification consider using ASD at low level.
Temperature – low (permanently below 0°C)	Aspirating system	Use ASD located outside cold environment with condensation filters
Temperature – rapidly changing	SMART <sup>3</sup>	Use a short delay to prevent thermal alarm, SMART will ensure optical does not false alarm.
Vehicle exhausts (occasional)	SMART <sup>4</sup>	Scenario 5 has been specifically developed.
Welding or brazing	SMART <sup>4</sup>	Scenario 2 has been developed for the purpose.

# Detector Selection – General Applications

General application	Recommendation
Air extraction ducts	Duct Detector
Air Handling Unit (AHU) rooms/plant rooms and lift motor rooms	Aspirating system
Animal houses, stables, zoos etc	Aspirating system
Atriums	Aspirating system & beam
Battery re-charge rooms	VIEW
Bedrooms	SMART <sup>4</sup> or SMART <sup>3</sup>
Bedroom with adjacent bathroom	SMART <sup>4</sup>
Bedroom with bath and/or kitchen attached	SMART <sup>4</sup>
Bedrooms – Smoking	SMART <sup>4</sup>
Boiler rooms	High temperature heat
Cable duct ways	Aspirating system & heat
Car parks (enclosed)	SMART <sup>3</sup> or Heat
Changing rooms alongside showers etc.	Aspirating system
Churches or cathedrals with open high ceilings	BEAM or Aspirating
Cold storage	Aspirating system
Corridors, stairwells or internal passageways	SMART <sup>3</sup> or Optical
Data centres/server rooms	VIEW or Aspirating
Electrical switch or plant rooms	SMART <sup>4</sup> or SMART <sup>3</sup>
Areas of high electrical fields	Aspirating system
Factories	SMART <sup>3</sup> or SMART <sup>4</sup>
Flour mills	SMART <sup>4</sup>
Garage work areas	SMART <sup>4</sup>
Heritage buildings e.g. historic house	Aspirating system
Hospitals	SMART <sup>4</sup> or SMART <sup>3</sup>
Kitchens	Heat
Laundry rooms	SMART <sup>4</sup> or Aspirating
Laundry storage rooms	SMART <sup>4</sup>

General application	Recommendation
Libraries	VIEW or Aspirating
Manufacturing – high technology/scientific laboratories	SMART <sup>4</sup> or Aspirating
Manufacturing – heavy industrial with strobes or welding	SMART <sup>4</sup>
Museums and art galleries	VIEW & SMART <sup>4</sup>
Nightclubs and theatres	SMART <sup>4</sup>
Offices or working areas	SMART <sup>3</sup>
Paint shops and car body repair shops	Heat
Prisons/secure accommodation	Aspirating system
Pubs, bars, restaurants	SMART <sup>4</sup> or SMART <sup>3</sup>
Retail units (high ceilings)	Aspirating system
Retail shops (normal ceiling height)	SMART <sup>3</sup>
Retail storerooms	SMART <sup>4</sup> or Aspirating
Retirement homes	SMART <sup>4</sup> or SMART <sup>3</sup>
Steam rooms, saunas or shower areas	SMART <sup>4</sup> or Aspirating
Tunnels	Beam
Unheated spaces – attics, pump houses, service intake rooms etc.	SMART <sup>3</sup>
Warehouses	Aspirating system
Warehouse loading bays	SMART <sup>4</sup>

## Notifier SMART Selector App – for iOS (iPhone, iPad) and Android (tablets and phones)

Easily find the right detector for specific environmental conditions. In addition our SMART Selector app offers an overview of the comprehensive detector portfolio from Notifier.

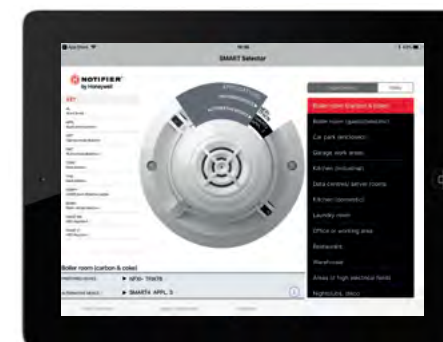





**NOTIFIER by Honeywell**

Tel: +44 (0) 203 409 1779

[www.notifierfiresystems.co.uk](http://www.notifierfiresystems.co.uk)

All specifications are subject to change without notice.  
NOTIFIER® is a registered trademark of Honeywell International Inc.

©2023 by Honeywell International Inc. All rights reserved.  
Unauthorized use of this document is strictly prohibited.

 **NOTIFIER®**  
by Honeywell